

По вопросам продаж и поддержки обращайтесь:

Архангельск (8182)63-90-72
Астана (7172)727-132
Астрахань (8512)99-46-04
Барнаул (3852)73-04-60
Белгород (4722)40-23-64
Брянск (4832)59-03-52
Владивосток (423)249-28-31
Волгоград (844)278-03-48
Вологда (8172)26-41-59
Воронеж (473)204-51-73
Екатеринбург (343)384-55-89

Иваново (4932)77-34-06
Ижевск (3412)26-03-58
Казань (843)206-01-48
Калининград (4012)72-03-81
Калуга (4842)92-23-67
Кемерово (3842)65-04-62
Киров (8332)68-02-04
Краснодар (861)203-40-90
Красноярск (391)204-63-61
Курск (4712)77-13-04
Липецк (4742)52-20-81

Магнитогорск (3519)55-03-13
Москва (495)268-04-70
Мурманск (8152)59-64-93
Набережные Челны (8552)20-53-41
Нижний Новгород (831)429-08-12
Новокузнецк (3843)20-46-81
Новосибирск (383)227-86-73
Омск (3812)21-46-40
Орел (4862)44-53-42
Оренбург (3532)37-68-04
Пенза (8412)22-31-16

Пермь (342)205-81-47
Ростов-на-Дону (863)308-18-15
Рязань (4912)46-61-64
Самара (846)206-03-16
Санкт-Петербург (812)309-46-40
Саратов (845)249-38-78
Севастополь (8692)22-31-93
Симферополь (3652)67-13-56
Смоленск (4812)29-41-54
Сочи (862)225-72-31
Ставрополь (8652)20-65-13

Сургут (3462)77-98-35
Тверь (4822)63-31-35
Томск (3822)98-41-53
Тула (4872)74-02-29
Тюмень (3452)66-21-18
Ульяновск (8422)24-23-59
Уфа (347)229-48-12
Хабаровск (4212)92-98-04
Челябинск (351)202-03-61
Череповец (8202)49-02-64
Ярославль (4852)69-52-93

Единый адрес: ccn@nt-rt.ru | <http://www.conec.nt-rt.ru>

SECTION 5

μTCA™ POWER MODULE CONNECTORS

The MicroTCA standard now provides a specification that permits the design of small, economical and flexible systems from standardized modules.

Power modules, which ensure a secure power supply for the system, are also a part of MicroTCA system design criteria.

The power feed from an external source is accomplished by way of a cable connected to the external source and ending locally in a power input connector mounted on the front side of the power module.

The MicroTCA .0 specification defines appropriate interfaces for this. An interface has been chosen for the input side of MicroTCA direct current power modules which is based on the dual port Combination D-SUB connector.

Form factor 7W2 modules are used for power supplies of -48V and -60V.

Form factor 9W4 is used for +24V power supplies to provide coding and differentiation. The specified connectors consist of two power contacts and two signal contacts.

The signal contacts are used for hot-swap control purposes and, according to specification, should be shorted with a jumper on the cable side of the connector.



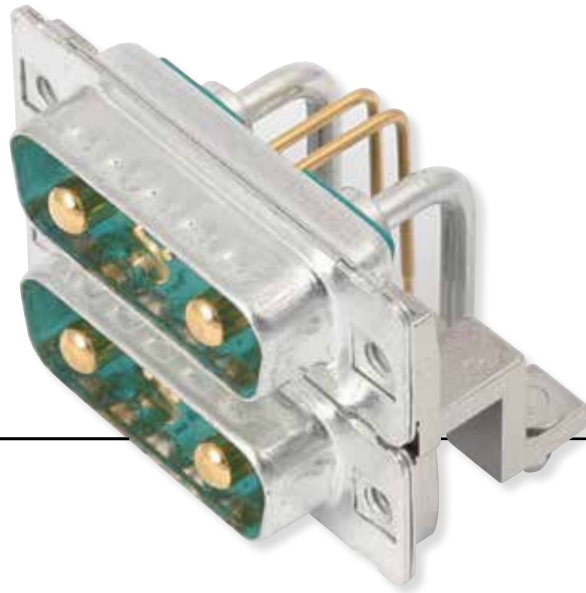

A 24 amp rating per contact is required for the 7W2 version and a 49 amp rating per contact for the 9W4 version.

The contact may not have an operational temperature rise in excess of 30° C.

The machined precision contacts used in CONEC MicroTCA power module input connectors offer considerable power reserves and are specified for 250 insertion cycles.

The CONEC product line encompasses connectors for installation on the PC board in dual and single port designs for through hole soldering and SMT. Filtered version available on request. Socket connectors are available for use with cable. These connectors are offered with signal contacts which are bridged and unbridged versions.

Included in the product offering are slim line, low profile hoods and suitable connectors.



MEMBER OF



TECHNICAL DATA

Materials		
Insulator	PBT (UL 94-V0)	
Power Contacts	Copper alloy, Precision machined contacts	Mating side Au over Ni
		Soldering side Sn over Ni
Signal contacts	Copper alloy, Precision machined contacts	Mating side Au over Ni
		Soldering side Au over Ni
Shell	Steel	Tin plated
Mounting bracket	Zink die-cast	Tin plated
4-40 UNC threaded insert	Copper alloy	Tin plated
Hex bolt with 4-40 UNC threaded insert and washers	Steel	Nickel plated
PCB clip for .063" / 1.6 mm PCB	Copper alloy	Tin plated
Mechanical and electrical characteristics		
Current rating	Power contacts	24 A at max. 30°C temperature rise
	Signal contacts	7.5 A nominal
Clearance- and creepage distance	Power contacts	.059" / 1.5 mm min.
	Signal contacts	.016" / 0.4 mm min.
	Signal and power contacts	.059" / 1.5 mm min.
	Power contacts and shell	.059" / 1.5 mm min.
	Signal contact and shell	.059" / 1.5 mm min.
Insulation resistance	Power contact	5000 mΩ min.
	Signal contact	5000 mΩ min.
	Signal and power contacts	5000 mΩ min.
	Power contacts and Shell	5000 mΩ min.
	Signal contact and Shell	5000 mΩ min.
Dielectric with standing voltage	1000 V r.m.s.	
Mating cycles	250 cycles	
Mating force	100 N max.	
Unmating force	65 N max.	

Technical specifications are subject to change without notice.

SOLDER PROFILE

Connector Type	Preheating		Solder terminal dipping parameters	
	max. Temperature	Duration	max. Solder bath Temperature	max. Terminal Immersion Time
Filter D-SUB	100°C	30s	260°C	5s
Combo D-SUB Filter	120°C	120s	260°C	5s
Filter D-SUB Water Resistant	100°C	30s	240°C	5s
Combo D-SUB Water Resistant	120°C	120s	240°C	5s
D-SUB Water Resistant	120°C	120s	240°C	5s
D-SUB Solid Body Type Water Resistant	150°C	180s	265°C	8s
RJ45 Modular Jack Filtered	150°C	180s	265°C	8s
Filter Plates	150°C	180s	265°C	8s

Recommended wave-solder parameters for CONEC connectors.

MICROTCA POWER MODUL INPUT CONNECTORS

Plug connector – Solder pin angled – Dual port style – Through hole

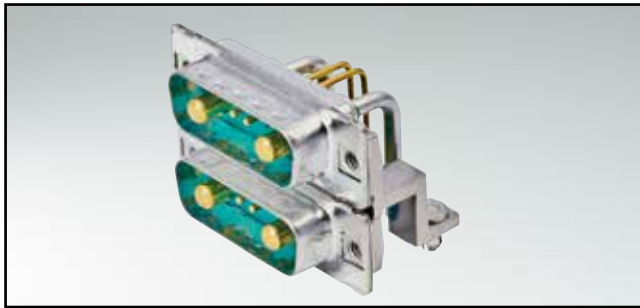

RoHS compliant

DESCRIPTION

- Standard version according to MTCA.0 specification
- Design 7W2 for -48/-60 V Power modul
- Design: 2 power contacts 24 A / 2 signal contacts per port
- Mounting styles:
 - Mounting bracket with PCB clip, 4-40 UNC threaded insert
 - Mounting bracket with PCB clip, 4-40 UNC hex bolt
- Note for 9W4 product please contact factory
- Precision machined contacts

PRODUCT DRAWING

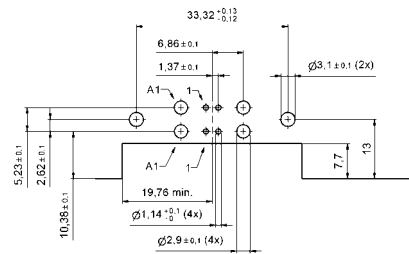
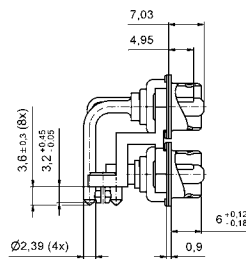
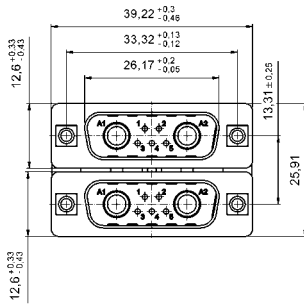

Mounting style:
Mounting bracket with PCB clip,
4-40 UNC threaded insert

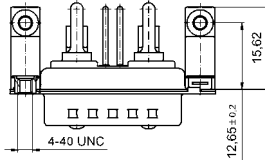

Mounting style:
Mounting bracket with PCB clip,
threaded insert and 4-40 UNC hex bolt

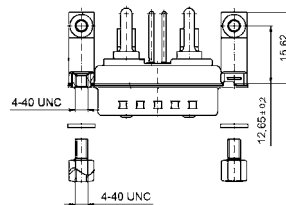

ORDER DATA

PLUG CONNECTOR		
Design	Mounting style	Part Number
7W2	Mounting bracket with PCB clip/Threaded insert and 4-40 UNC Hex bolt	13-000011
7W2	Mounting bracket with PCB clip/4-40 UNC Threaded insert	13-000021

PCB clip .122"/3.1 ± .004"/0.10 mm hole diameter and .063"/1.6 mm circuit board thickness

MICROTCA POWER MODUL INPUT CONNECTORS

Plug connector – Solder pin angled – Dual port style – Filter version – Through hole

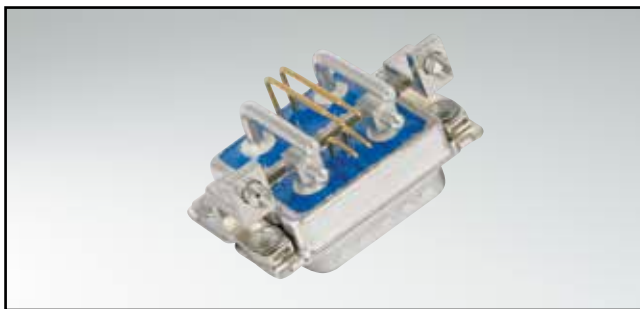

RoHS compliant

DESCRIPTION

- Standard version according to MTCA.0 specification
- Filtered power contacts with 54 nF or 10 nF Capacitance
- Signal contacts are not filtered
- Design 7W2 for -48/-60 V Power modul
- Design: 2 power contacts 24 A / 2 signal contacts per port
- Mounting styles:
 - Mounting bracket with PCB clip, 4-40 UNC threaded insert
 - Mounting bracket with PCB clip, 4-40 UNC hex bolt
- Note for 9W4 product please contact factory
- Precision machined contacts

PRODUCT DRAWING

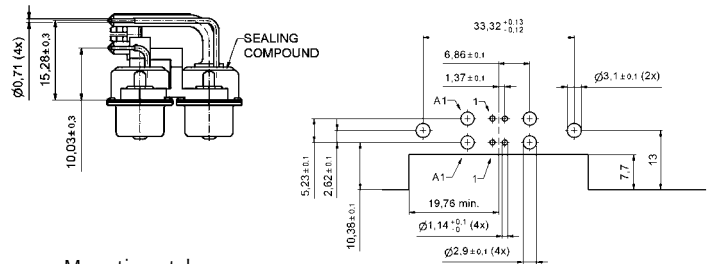
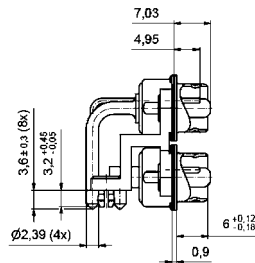
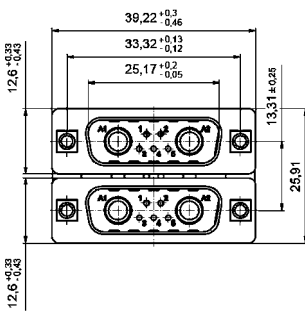

Mounting style:
Mounting bracket with PCB clip,
4-40 UNC threaded insert

Mounting style:
Mounting bracket with PCB clip,
threaded insert and 4-40 UNC hex bolt

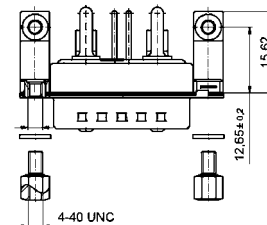
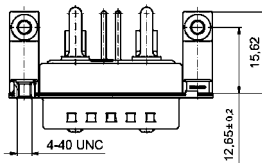

ORDER DATA

PLUG CONNECTOR			
Design	Mounting style	Filter capacitance for power contact	Part Number
7W2	Mounting bracket with PCB clip/4-40 UNC Hex bolt	54 nF	24-000031
7W2	Mounting bracket with PCB clip/4-40 UNC Threaded insert	54 nF	24-000011
7W2	Mounting bracket with PCB clip/4-40 UNC Hex bolt	10 nF	24-000041
7W2	Mounting bracket with PCB clip/4-40 UNC Threaded insert	10 nF	24-000051

PCB clip .122"/3.1 ± .004"/0.10 mm hole diameter and .063"/1.6 mm circuit board thickness

MICROTCA POWER MODUL INPUT CONNECTORS

Plug connector – SMT version – Suitable for reflow – Angled – Dual port style

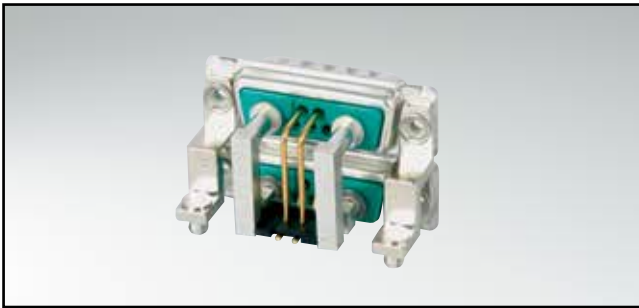

RoHS compliant

DESCRIPTION

- SMT Version with contact spacer plate
- Design 7W2 for -48/-60V power modul
- Design: 2 power contacts 35 A / 2 signal contacts per port
- Mounting styles:
 - Mounting bracket with PCB clip, 4-40 UNC threaded insert
 - Mounting bracket with PCB clip, 4-40 UNC hex bolt
- Note for 9W4 product please contact factory
- Precision machined contacts

PRODUCT DRAWING

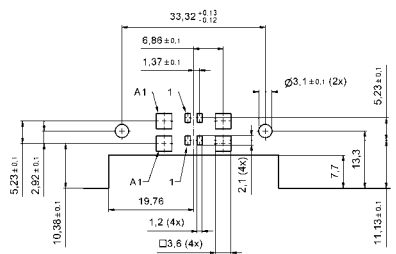
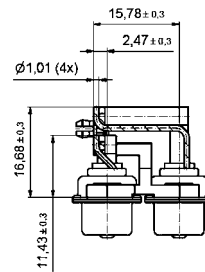
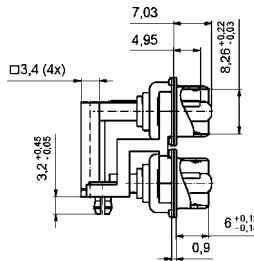
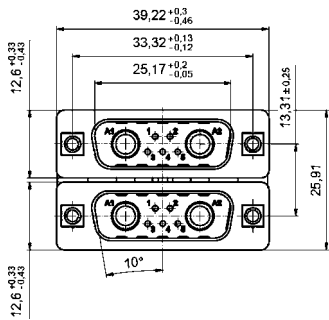

Mounting style:
Mounting bracket with PCB clip,
4-40 UNC threaded insert

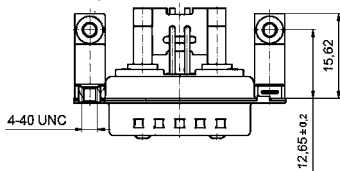

Mounting style:
Mounting bracket with PCB clip,
threaded insert and 4-40 UNC hex bolt

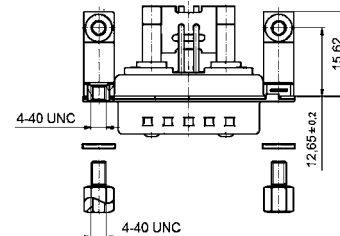

ORDER DATA

PLUG CONNECTOR		
Design	Mounting style	Part Number
7W2	Mounting bracket with PCB clip/Threaded insert and 4-40 UNC Hex bolt	13-000031
7W2	Mounting bracket with PCB clip/4-40 UNC Threaded insert	13-000041

PCB clip .122"/3.1 ± .004"/0.10 mm hole diameter and .063"/1.6 mm circuit board thickness

MICROTCA POWER MODUL INPUT CONNECTORS

Plug connector – Solder pin angled – Through hole

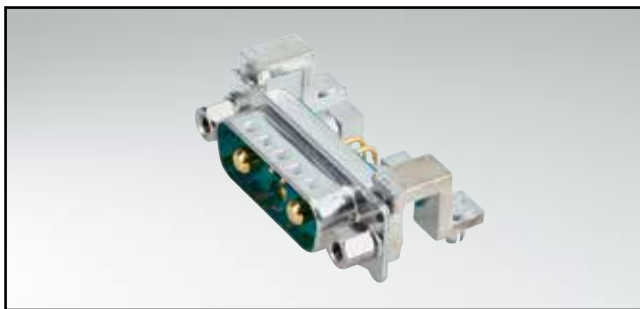

RoHS compliant

DESCRIPTION

- Single port version for MicroTCA PCB layout
- Design 7W2 for -48/-60 V power modul
- Design: 2 power contacts 24 A / 2 signal contacts
- Mounting styles:
 - Mounting bracket with PCB clip, 4-40 UNC threaded insert
 - Mounting bracket with PCB clip, 4-40 UNC hex bolt
- Note for 9W4 product please contact factory
- Precision machined contacts

PRODUCT DRAWING

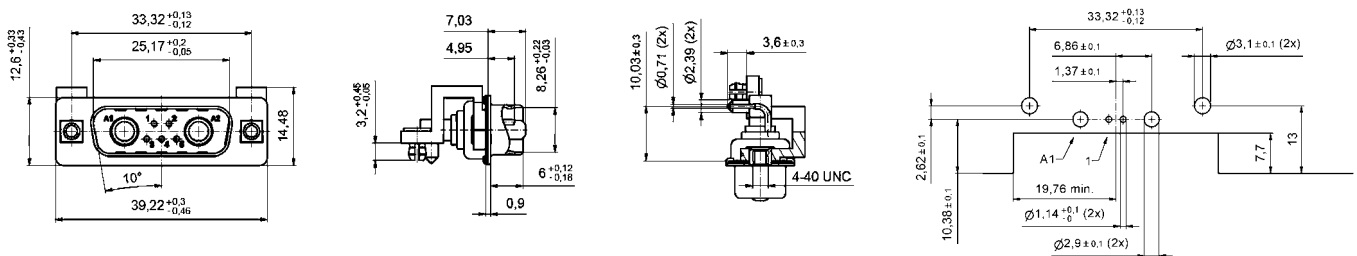

Mounting style:
Mounting bracket with PCB clip,
4-40 UNC threaded insert

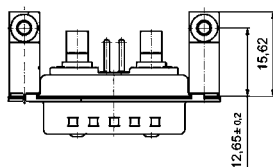

Mounting style:
Mounting bracket with PCB clip,
threaded insert and 4-40 UNC hex bolt

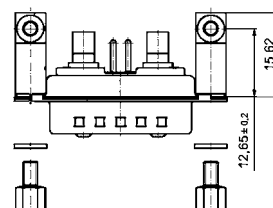

ORDER DATA

PLUG CONNECTOR		
Design	Mounting style	Part Number
7W2	Mounting bracket with PCB clip/Threaded insert and 4-40 UNC Hex bolt	13-000051
7W2	Mounting bracket with PCB clip/4-40 UNC Threaded insert	13-000061

PCB clip .122"/3.1 ± .004"/0.10 mm hole diameter and .063"/1.6 mm circuit board thickness

MICROTCA POWER MODUL INPUT CONNECTORS

Plug connector – Solder pin angled – Filter version – Through hole



RoHS compliant

DESCRIPTION

- Single port version for MicroTCA PCB layout
- Design 7W2 for -48/-60 V power modul
- Design: 2 power contacts 24 A / 2 signal contacts
- Mounting styles:
 - Mounting bracket with PCB clip, 4-40 UNC threaded insert
 - Mounting bracket with PCB clip, 4-40 UNC hex bolt
- Note for 9W4 product please contact factory
- Precision machined contacts

PRODUCT DRAWING

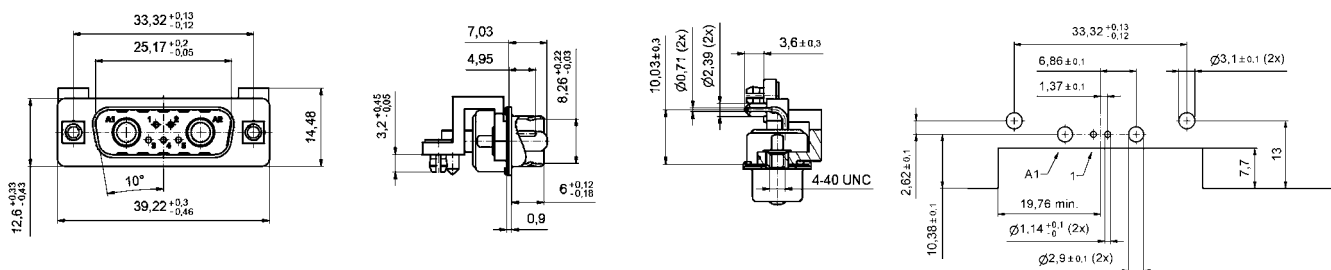

Mounting style:
Mounting bracket with PCB clip,
4-40 UNC threaded insert

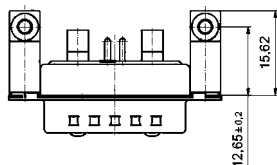

Mounting style:
Mounting bracket with PCB clip,
threaded insert and 4-40 UNC hex bolt

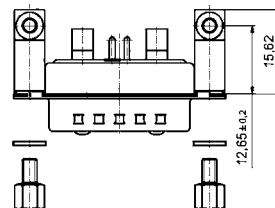

ORDER DATA

PLUG CONNECTOR			
Design	Mounting style	Filter capacitance for power contact	Part Number
7W2	Mounting bracket with PCB clip/4-40 UNC Hex bolt	54 nF	24-000061
7W2	Mounting bracket with PCB clip/4-40 UNC Threaded insert	54 nF	24-000071
7W2	Mounting bracket with PCB clip/4-40 UNC Hex bolt	10 nF	24-000081
7W2	Mounting bracket with PCB clip/4-40 UNC Threaded insert	10 nF	24-000091

PCB clip .122"/3.1 ± .004"/0.10 mm hole diameter and .063"/1.6 mm circuit board thickness

MICROTCA POWER MODUL INPUT CONNECTORS

Plug connector – SMT version – Suitable for reflow – Angled

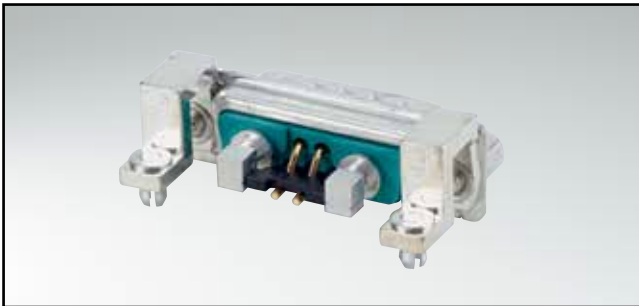

RoHS compliant

DESCRIPTION

- SMT Version with contact spacer plate
- Design 7W2 for -48/-60V power modul
- Design: 2 power contacts 35 A / 2 signal contacts
- Mounting styles:
 - Mounting bracket with PCB clip, 4-40 UNC threaded insert
 - Mounting bracket with PCB clip, 4-40 UNC hex bolt
- Note for 9W4 product please contact factory
- Precision machined contacts

PRODUCT DRAWING

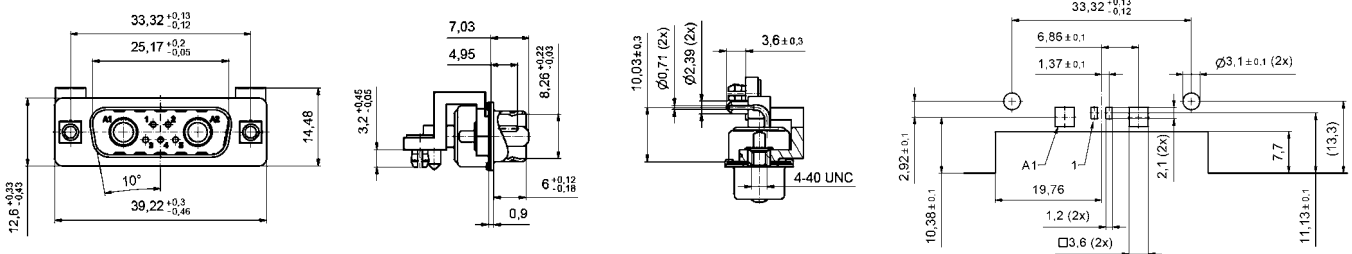

Mounting style:
Mounting bracket with PCB clip,
4-40 UNC threaded insert

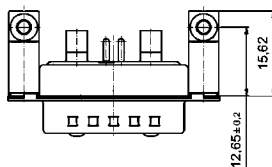

Mounting style:
Mounting bracket with PCB clip,
threaded insert and 4-40 UNC hex bolt

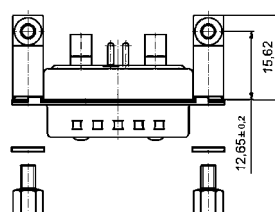

ORDER DATA

PLUG CONNECTOR		
Design	Mounting style	Part Number
7W2	Mounting bracket with PCB clip/Threaded insert and 4-40 UNC Hex bolt	13-000071
7W2	Mounting bracket with PCB clip/4-40 UNC Threaded insert	13-000081

PCB clip .122"/3.1 ± .004"/0.10 mm hole diameter and .063"/1.6 mm circuit board thickness

POWER MODUL INPUT CONNECTOR

Plug connector – Solder pin – Angled – Through hole

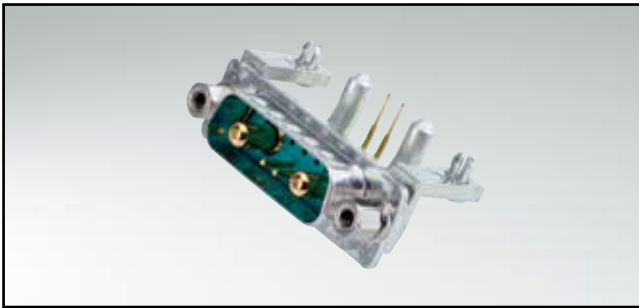

RoHS compliant

DESCRIPTION

- 7W2 Combination D-SUB Connector
- Design: 2 power contacts 40 A / 2 signal contacts
- Mounting styles:
 - Mounting bracket with PCB clip, 4-40 UNC threaded insert
 - Mounting bracket with PCB clip, 4-40 UNC hex bolt
- Note for 9W4 product please contact factory
- Precision machined contacts

PRODUCT DRAWING

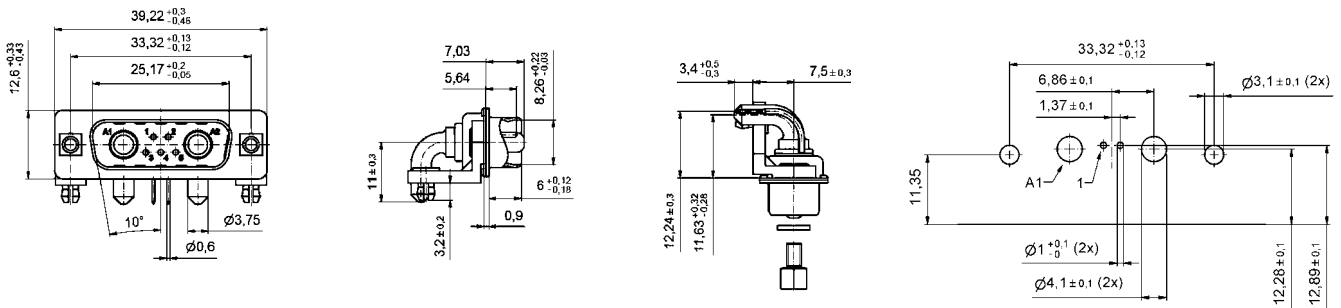

Mounting style:
Mounting bracket with PCB clip,
4-40 UNC threaded insert

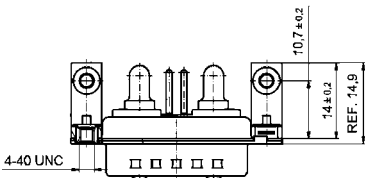

Mounting style:
Mounting bracket with PCB clip,
threaded insert and 4-40 UNC hex bolt

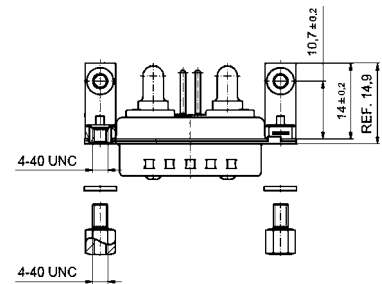

ORDER DATA

PLUG CONNECTOR		
Design	Mounting style	Part Number
7W2	Mounting bracket with PCB clip/Threaded insert and 4-40 UNC Hex bolt	13-000091
7W2	Mounting bracket with PCB clip/4-40 UNC Threaded insert	13-000101

PCB clip .122"/3.1 ± .004"/0.10 mm hole diameter and .063"/1.6 mm circuit board thickness

POWER MODUL INPUT CONNECTOR

Plug connector – Solder pin – Angled – Filter version – Through hole



RoHS compliant

DESCRIPTION

- 7W2 Combination D-SUB Connectors
- Design: 2 power contacts 40 A / 2 signal contacts
- Filtered power contacts with 54 nF or 10 nF Capacitance
- Signal contacts are not filtered
- Mounting styles:
 - Mounting bracket with PCB clip, 4-40 UNC threaded insert
 - Mounting bracket with PCB clip, 4-40 UNC hex bolt
- Note for 9W4 product please contact factory
- Precision machined contacts

PRODUCT DRAWING

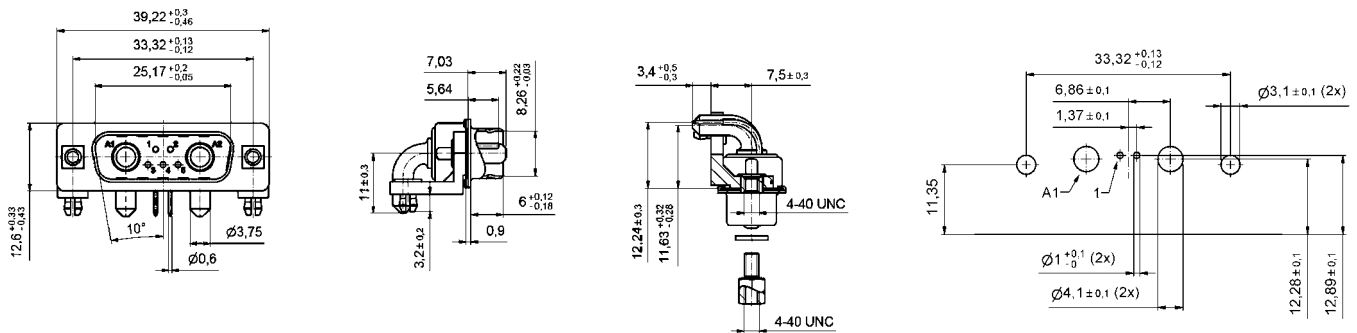

Mounting style:
Mounting bracket with PCB clip,
4-40 UNC threaded insert

Mounting style:
Mounting bracket with PCB clip,
threaded insert and 4-40 UNC hex bolt

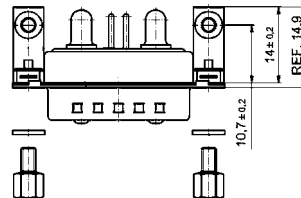
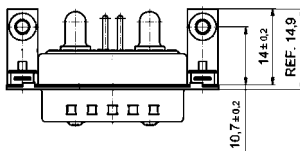

ORDER DATA

PLUG CONNECTOR			
Design	Mounting style	Filter capacitance for power contact	Part Number
7W2	Mounting bracket with PCB clip/4-40 UNC Hex bolt	54 nF	24-000101
7W2	Mounting bracket with PCB clip/4-40 UNC Threaded insert	54 nF	24-000111
7W2	Mounting bracket with PCB clip/4-40 UNC Hex bolt	10 nF	24-000121
7W2	Mounting bracket with PCB clip/4-40 UNC Threaded insert	10 nF	24-000131

PCB clip .122"/3.1 ± .004"/0.10 mm hole diameter and .063"/1.6 mm circuit board thickness

POWER MODUL INPUT CONNECTOR

Plug connector – Solder pin – Straight – Through hole

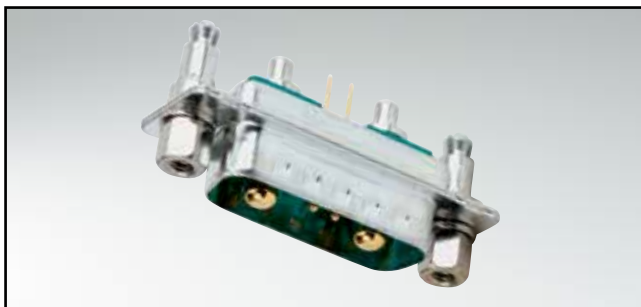

RoHS compliant

DESCRIPTION

- 7W2 Combination D-SUB Connectors
- Design: 2 power contacts 24 A / 2 signal contacts
- Mounting styles:
 - 4-40 UNC threaded rear spacer with PCB clip,
 - 4-40 UNC threaded insert
 - 4-40 UNC threaded rear spacer with PCB clip,
 - 4-40 UNC hex bolt
- Note for 9W4 product please contact factory
- Precision machined contacts

PRODUCT DRAWING

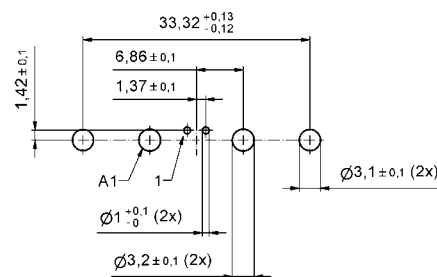
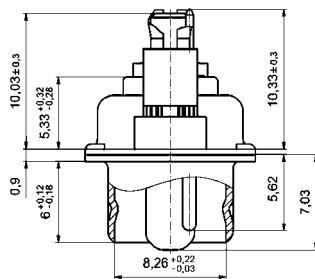
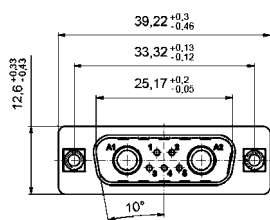

Mounting style:

4-40 UNC threaded rear spacer with PCB clip,
4-40 UNC threaded insert

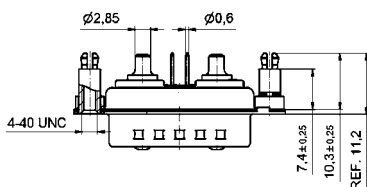

Mounting style:

4-40 UNC threaded rear spacer with PCB clip,
4-40 UNC hex bolt

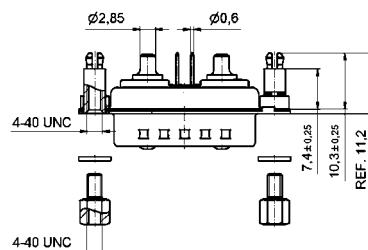

ORDER DATA

PLUG CONNECTOR		
Design	Mounting style 4-40 UNC	Part Number
7W2	Threaded rear spacer with PCB clip / Hex bolt	13-000111
7W2	Threaded rear spacer with PCB clip / Threaded insert	13-000121

PCB clip .122" / 3.1 ± .004" / 0.10 mm hole diameter

POWER MODUL INPUT CONNECTOR

Plug connector – Solder pin – Straight – Filter version – Through hole



RoHS compliant

DESCRIPTION

- 7W2 Combination D-SUB Connectors
- Design: 2 power contacts 24 A / 2 signal contacts
- Filtered power contacts with 54 nF oder 10 nF capacitance
- Mounting styles:
 - 4-40 UNC threaded rear spacer with PCB clip,
 - 4-40 UNC threaded insert
 - 4-40 UNC threaded rear spacer with PCB clip,
 - 4-40 UNC hex bolt
- Note for 9W4 product please contact factory
- Precision machined contacts

PRODUCT DRAWING

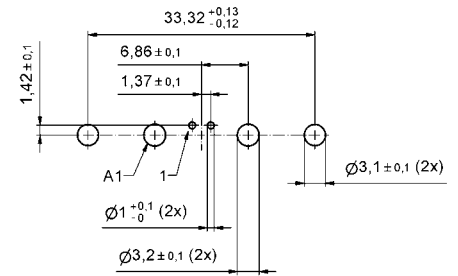
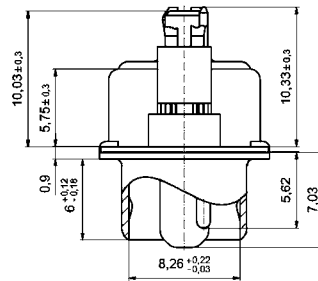
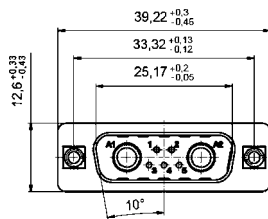

Mounting style:

4-40 UNC threaded rear spacer with PCB clip,
4-40 UNC threaded insert

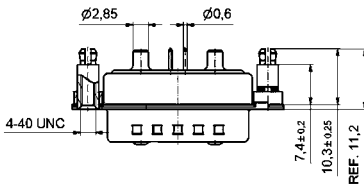

Mounting style:

4-40 UNC threaded rear spacer with PCB clip,
4-40 UNC hex bolt

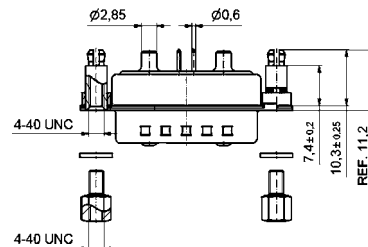

ORDER DATA

PLUG CONNECTOR			
Design	Mounting style 4-40 UNC	Filter capacitance for power contact	Part Number
7W2	Threaded rear spacer with PCB clip/Hex bolt	54 nF	24-000141
7W2	Threaded rear spacer with PCB clip/Threaded insert	54 nF	24-000151
7W2	Threaded rear spacer with PCB clip/Hex bolt	10 nF	24-000161
7W2	Threaded rear spacer with PCB clip/Threaded insert	10 nF	24-000171

PCB clip .122"/3.1 ± .004" / 0.10 mm hole diameter

MICROTCA POWER INPUT CONNECTOR

Socket connector – Solder cup or crimp body

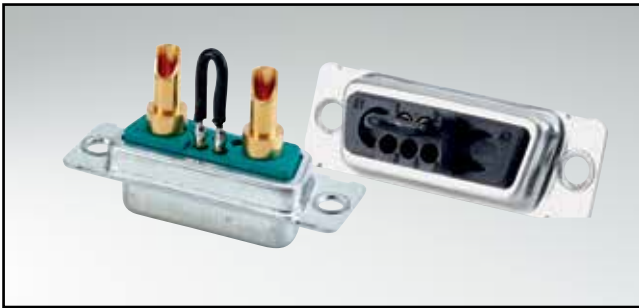

RoHS compliant

DESCRIPTION

- 7W2 MicroTCA Design: 2 Power / 2 signal contacts
- Available with bridged and unbridged signal contacts
- Mounting style: with Through-hole .118"/3.0 mm
- Power contacts solder cup or crimp type wire size
- Note for 9W4 product please contact factory

PRODUCT DRAWING

Solder cup

AWG	X	Current Rating
10-12	3.5	max. 30 A
12-14	2.7	max. 20 A
16-20	1.8	max. 10 A

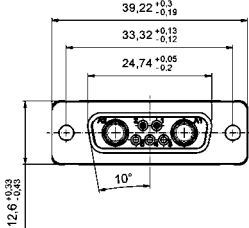

Crimp version

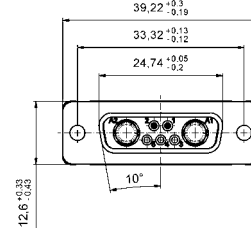

With signal contacts

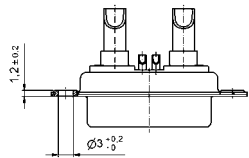

Without signal contacts

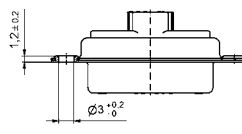

With bridged signal contact

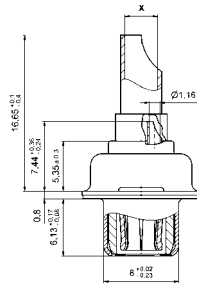
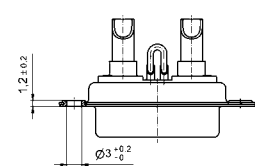

with bridged signal contacts

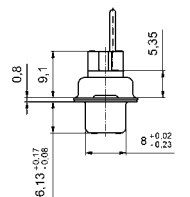
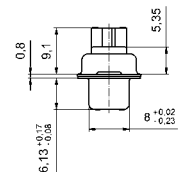
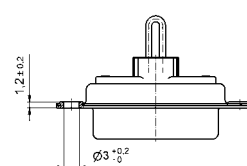

ORDER DATA

SOCKET CONNECTOR VERSION SOLDER CUP

Design	Wire size	Current rating	Mounting style	Signal contacts	Part Number
7W2	AWG 10...12	30 A	Through-hole .118"/3.0 mm	Unbridged	13-000131
7W2	AWG 12...14	20 A	Through-hole .118"/3.0 mm	Unbridged	13-000141
7W2	AWG 16...20	10 A	Through-hole .118"/3.0 mm	Unbridged	13-000151
7W2	AWG 10...12	30 A	Through-hole .118"/3.0 mm	Bridged	13-000161
7W2	AWG 12...14	20 A	Through-hole .118"/3.0 mm	Bridged	13-000171
7W2	AWG 16...20	10 A	Through-hole .118"/3.0 mm	Bridged	13-000181

SOCKET CONNECTOR CRIMP BODY

Design	Design	Mounting style	Crimp signal contacts	Part Number
7W2	Crimp body	Through-hole .118"/3.0 mm	Without signal contacts	13-000190
7W2	Crimp body	Through-hole .118"/3.0 mm	Bridged	13-000201

MICROTCA POWER INPUT CONTACTS

Socket contact – Crimp body – Precision machined

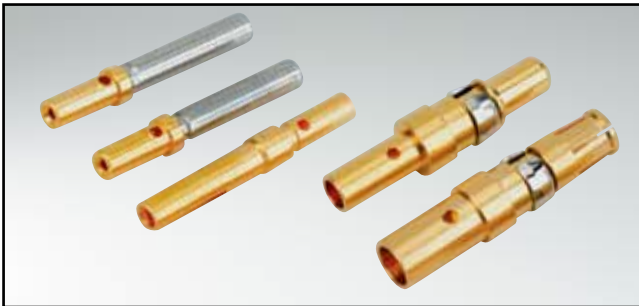

RoHS compliant

DESCRIPTION

- Standard packaging
- Precision machined contacts
- Quality class 1 is standard
- Other quality classes on request
- Short power contacts, offered for use in MicroTCA specific hood

PRODUCT DRAWING

Signal crimp contact (Standard version)

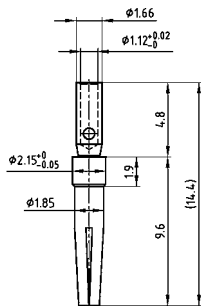

Signal crimp contact (closed entry version)

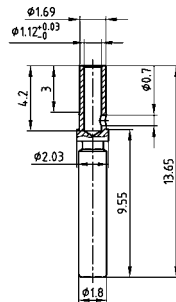

Power crimp contact (standard version)

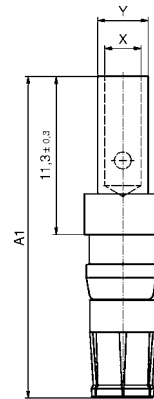

Power crimp contact (short version)

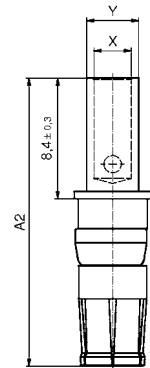

AWG	A ₁	A ₂	X	Y	Current Rating
8-10		20.08	4.6	5.35	40A
10-12	22.98	20.08	3.7	4.7	30 A
12-14	22.98	20.08	2.6	3.6	20 A
16-20	22.98	20.08	1.7	2.6	10 A

ORDER DATA

SOCKET CONTACT			
Version	Wire cross section	Current rating	Part Number
Signal crimp (standard version)	AWG 20...24	7.5 A	162C18709X
Power crimp (standard version)	AWG 10...12 / A = 22.98	30 A	132C11039X
Power crimp (standard version)	AWG 12...14 / A = 22.98	20 A	132C11029X
Power crimp (standard version)	AWG 16...20 / A = 22.98	10 A	132C11019X
Signal crimp (closed entry version)	AWG 20...24	7.5 A	132C15019X
Power crimp (for MicroTCA) (short version)	AWG 8...10 / A = 20.08	40 A	13-000321
Power crimp (for MicroTCA) (short version)	AWG 10...12 / A = 20.08	30 A	13-000311
Power crimp (for MicroTCA) (short version)	AWG 12...14 / A = 20.08	20 A	13-000301
Power crimp (for MicroTCA) (short version)	AWG 16...20 / A = 20.08	10 A	13-000291

MICROTCA CABLE HOOD AND CONNECTOR SET

Plastic hood with crimp connector body – Straight cable entry



RoHS compliant

DESCRIPTION

- Compact 7W2 shell inclusive crimp-socket connector
- Available with bridged signal contacts
- Short 4-40 UNC screws with Phillips or Allen key
- Material Housing: PBT GF; UL 94 V0, black
- Integrated strain relief
- Power contacts for wire size AWG 8 up to AWG 20
- This hood only fits this included connector, sold together as a set
- Choose short power contacts from previous page, sold separately

PRODUCT DRAWING

Hood with short screw
(Socket connector included)

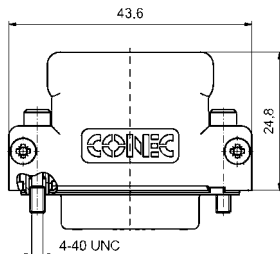
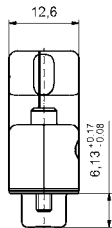
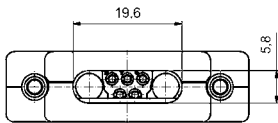
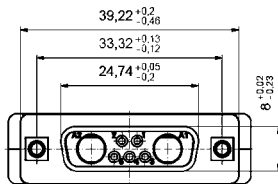

Hood with jack screw
(Socket connector included)

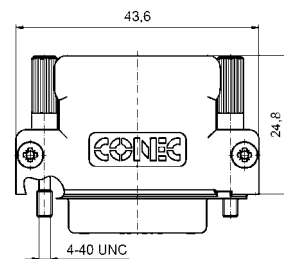
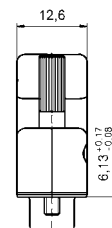
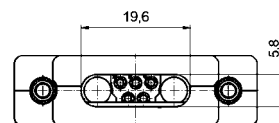
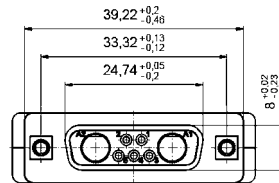

ORDER DATA

SOCKET CONNECTOR

Design	Signal contacts	Screw design	Part Number
Hood / Crimp socket connector 7W2	Without signal contacts	Short / Allen key	13-000210
Hood / Crimp socket connector 7W2	Without signal contacts	Short / Phillips head	13-000220
Hood / Crimp socket connector 7W2	Bridged	Short / Allen key	13-000231
Hood / Crimp socket connector 7W2	Bridged	Short / Phillips head	13-000241
Hood / Crimp socket connector 7W2	Without signal contacts	Jack screw / Allen key	13-000370
Hood / Crimp socket connector 7W2	Without signal contacts	Jack screw / Phillips head	13-000380
Hood / Crimp socket connector 7W2	Bridged	Jack screw / Allen key	13-000391
Hood / Crimp socket connector 7W2	Bridged	Jack screw / Phillips head	13-000401

MICROTCA CABLE HOOD

Metal design – Side cable entry



RoHS compliant

DESCRIPTION

- Cable hood for 7W2 MicroTCA Standard socket connector
- Suitable for other D-SUB Connectors
- Material: Zink die-cast
- Fastening with 4-40 UNC thread and jack screws
- Solide zink die-cast strain relief
- Plastic cable run integrated in shell
- Bulk or single packaged units

PRODUCT DRAWING

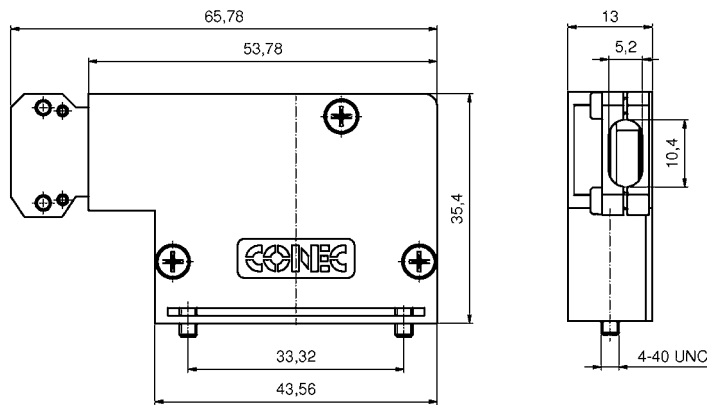

ORDER DATA

D-SUB MicroTCA Hood 7W2		
Type	Design	Part Number
7W2	Metal hood	16-000010

По вопросам продаж и поддержки обращайтесь:

Архангельск (8182)63-90-72
 Астана (7172)727-132
 Астрахань (8512)99-46-04
 Барнаул (3852)73-04-60
 Белгород (4722)40-23-64
 Брянск (4832)59-03-52
 Владивосток (423)249-28-31
 Волгоград (844)278-03-48
 Вологда (8172)26-41-59
 Воронеж (473)204-51-73
 Екатеринбург (343)384-55-89

Иваново (4932)77-34-06
 Ижевск (3412)26-03-58
 Казань (843)206-01-48
 Калининград (4012)72-03-81
 Калуга (4842)92-23-67
 Кемерово (3842)65-04-62
 Киров (8332)68-02-04
 Краснодар (861)203-40-90
 Красноярск (391)204-63-61
 Курск (4712)77-13-04
 Липецк (4742)52-20-81

Магнитогорск (3519)55-03-13
 Москва (495)268-04-70
 Мурманск (8152)59-64-93
 Набережные Челны (8552)20-53-41
 Нижний Новгород (831)429-08-12
 Новокузнецк (3843)20-46-81
 Новосибирск (383)227-86-73
 Омск (3812)21-46-40
 Орел (4862)44-53-42
 Оренбург (3532)37-68-04
 Пенза (8412)22-31-16

Пермь (342)205-81-47
 Ростов-на-Дону (863)308-18-15
 Рязань (4912)46-61-64
 Самара (846)206-03-16
 Санкт-Петербург (812)309-46-40
 Саратов (845)249-38-78
 Севастополь (8692)22-31-93
 Симферополь (3652)67-13-56
 Смоленск (4812)29-41-54
 Сочи (862)225-72-31
 Ставрополь (8652)20-65-13

Сургут (3462)77-98-35
 Тверь (4822)63-31-35
 Томск (3822)98-41-53
 Тула (4872)74-02-29
 Тюмень (3452)66-21-18
 Ульяновск (8422)24-23-59
 Уфа (347)229-48-12
 Хабаровск (4212)92-98-04
 Челябинск (351)202-03-61
 Череповец (8202)49-02-64
 Ярославль (4852)69-52-93

Единый адрес: ccn@nt-rt.ru | <http://www.conec.nt-rt.ru>