

По вопросам продаж и поддержки обращайтесь:

Архангельск (8182)63-90-72  
Астана (7172)727-132  
Астрахань (8512)99-46-04  
Барнаул (3852)73-04-60  
Белгород (4722)40-23-64  
Брянск (4832)59-03-52  
Владивосток (423)249-28-31  
Волгоград (844)278-03-48  
Вологда (8172)26-41-59  
Воронеж (473)204-51-73  
Екатеринбург (343)384-55-89

Иваново (4932)77-34-06  
Ижевск (3412)26-03-58  
Казань (843)206-01-48  
Калининград (4012)72-03-81  
Калуга (4842)92-23-67  
Кемерово (3842)65-04-62  
Киров (8332)68-02-04  
Краснодар (861)203-40-90  
Красноярск (391)204-63-61  
Курск (4712)77-13-04  
Липецк (4742)52-20-81

Магнитогорск (3519)55-03-13  
Москва (495)268-04-70  
Мурманск (8152)59-64-93  
Набережные Челны (8552)20-53-41  
Нижний Новгород (831)429-08-12  
Новокузнецк (3843)20-46-81  
Новосибирск (383)227-86-73  
Омск (3812)21-46-40  
Орел (4862)44-53-42  
Оренбург (3532)37-68-04  
Пенза (8412)22-31-16

Пермь (342)205-81-47  
Ростов-на-Дону (863)308-18-15  
Рязань (4912)46-61-64  
Самара (846)206-03-16  
Санкт-Петербург (812)309-46-40  
Саратов (845)249-38-78  
Севастополь (8692)22-31-93  
Симферополь (3652)67-13-56  
Смоленск (4812)29-41-54  
Сочи (862)225-72-31  
Ставрополь (8652)20-65-13

Сургут (3462)77-98-35  
Тверь (4822)63-31-35  
Томск (3822)98-41-53  
Тула (4872)74-02-29  
Тюмень (3452)66-21-18  
Ульяновск (8422)24-23-59  
Уфа (347)229-48-12  
Хабаровск (4212)92-98-04  
Челябинск (351)202-03-61  
Череповец (8202)49-02-64  
Ярославль (4852)69-52-93

Единый адрес: [ccn@nt-rt.ru](mailto:ccn@nt-rt.ru) | <http://www.conec.nt-rt.ru>

## SECTION 5

# COMBINATION CONNECTORS DIN EN

The combination connectors in accordance with DIN EN 60603-2 offer a variety of applications. The design allows a combination of signal, high current, high voltage and coaxial contacts.

Standard termination types such as solder cup, PCB solder tails, straight right angle and wire wrap tails are available.



# 60603-2

**Product features:**

- Saves space on your PCB
- Various termination method
- Cost factor, one item as compared with separate connectors
- Easy assembly of high power and coaxial contacts
- High power and coaxial contacts are screw-machine types
- Gold plating options available

Fully assembled connectors with high power or coaxial contacts are available.



## PART NUMBER CREATOR

9 0 7 8 M 2 M A T 1 1 X 9 0 X

**Type**

9 = Type M - DIN EN 60603-2

**Variations**

Type M = 40+4, 42+6, 52+2, 60+4, 78+2

Type M = 16+8, 24+8, 28+6

Mini type M = 8+4, 12+4, 20+2, 30+2

+ = to substitute "M" (look at example)

**Type of contact**

M = Male connector

F = Female connector

**Quality class for contacts**

A = Quality class 3 = 50 cycles

B = Quality class 2 = 400 cycles

C\* = Quality class 1 = 500 cycles \*on request

**Termination only for signal contacts**

N\* = Wire Wrap \*not available as male connector

R = solder pin straight

T\* = solder pin angled \*not available as female connector

**Termination for high power and coaxial contacts**

11/27 = Solder lug 10 A

12/28 = Solder lug 20 A

14/29 = Solder lug 40 A

19/39 = Solder pin straight 20 A

20/40 = Solder pin straight 40 A

18/17 = Solder pin angled 10 A

21/16 = Solder pin angled 20 A

23/15 = Solder pin angled 40 A

26/13 = 4 solder pins angled 40 A

31 = 5 solder pins straight 50 Ω

32 = 5 solder pins straight 50 Ω

33 = 5 solder pins straight 75 Ω

35 = 5 solder pins angled 50 Ω

36 = 5 solder pins angled 75 Ω

99 = without contacts

**Mounting style**

X9 = Mounting hole for screwed or rivet

**Standard**

OX = Standard

## TECHNICAL INFORMATION

### SKIN EFFECT

Alternating currents do not uniformly occupy the entire cross section of the conductor, rather inductance effect in the conductor deflects the current towards the surface of the conductor, whereby this deflection increases with the frequency. The resistive attenuation of a transmission line increases with the frequency as a result of this skin effect. The skin depth (equivalent thickness of the layer in which current flows) can be determined using

$$\delta = \frac{1}{\sqrt{f \pi \sigma \mu_0 \mu_r}}$$

f = frequency

$\sigma$  = conductivity of the conductor material

$\sigma_{Ag} = 62 \times 10^6 \text{ S/m}$

$\sigma_{Cu} = 58 \times 10^6 \text{ S/m}$

$\mu_0 = 1,256 \times 10^{-6} \text{ Vs / Am}$

$\mu_r$  ... relative permeability constant for the employed material

### VSWR-VALUE

The ration between the value of the largest and the smallest voltages on a loss-free line is known as the ripple or voltage standing wave ratio s (with  $1 \leq s < \infty$ ). The reciprocal value of the VSWR is known as the inverse voltage standing wave ratio m (with  $0 < m \leq 1$ ). (VSWR = Voltage standing wave ratio). The value of s is linked with the  $\rightarrow$  reflection coefficient r on s transmissionline according to the equation.

$$s = \frac{(1 + |r|)}{(1 - |r|)}$$

### CURRENT RATING / DERATING CURVE

Measurement is according to DIN 41640 part 3 whereas all power contacts are connected in series.

For test procedure - product-no. 9024M8FCR14X90X has been equipped with 124C10069X and 9024M8MCR14X90X with 123C10069X.

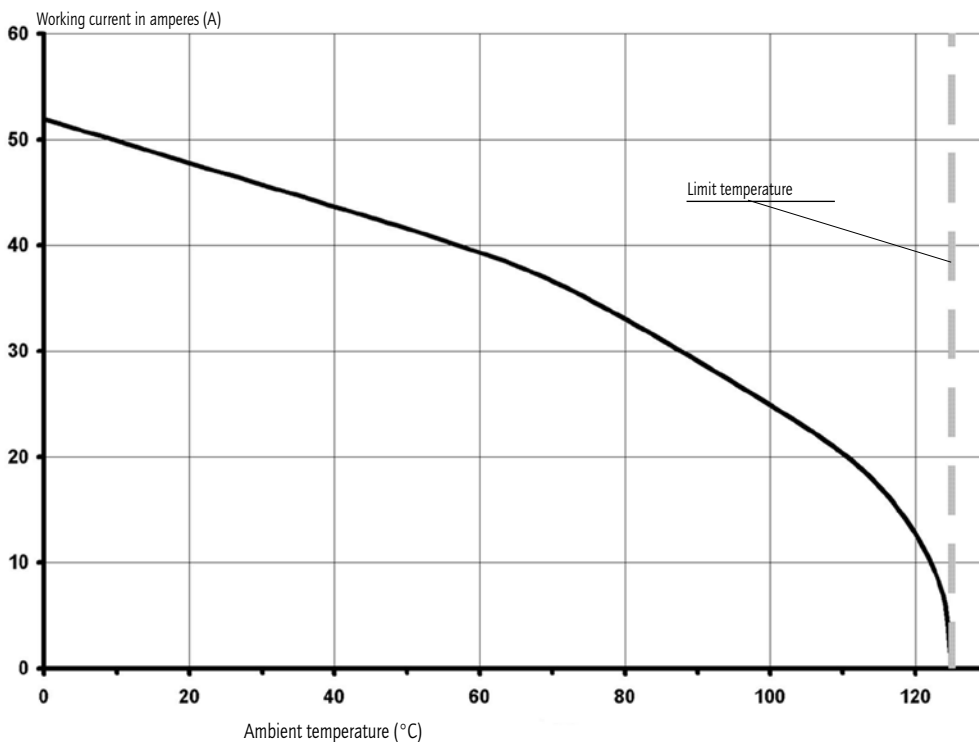

## TECHNICAL DATA

Materials	Type M	Coaxial contacts	High power contacts	High voltage contacts
Insulator	PBT GF UL94V-0	PTFE/PBT/PI		PTFE
Contact plating	gold over nickel			
Contact material	copper alloy			
Retaining clip	copper alloy			
Current rating (DC)	2 A	2 A	10 to 40 A	2 A
Test voltage	1000 V, 50 Hz			
Resistance between mated contacts	≤ 2.7 mΩ			
Insulation resistance		10 <sup>7</sup> MΩ		≥2x10 <sup>7</sup> MΩ
Volume resistivity	10 <sup>16</sup> Ωcm			
Dielectric strength	50 KV/ mm			
Characteristic impedance		50/75 Ω		
Contact resistance	inner conductor outer conductor	≤ 2.7 mΩ ≤ 2.7 mΩ	≤ 2.7 mΩ ≤ 2.7 mΩ	≤ 1 mΩ ≤ 2.7 mΩ
VSWR-value according to MIL-C-39012	1.2 GHz 1.5 GHz 2.0 GHz	≤ 1.2 ≤ 1.3 ≤ 1.5		
Dielectric voltage		750 V 50 Hz		3.8 kV
Frequency range		0 to 2 GHz		
Working voltage	250 V	250 V		max. 2.8 kV
Temperature range	-55 °C to +125 °C	-55 °C to +135 °C	-55 °C to +155 °C	-55 °C to +125 °C
Mating force per signal contact	≤ 3.4 N	≤ 7 N	≤ 7 N	≤ 5 N
Withdrawal force per signal contact	≥ 0.2 N	≤ 7 N	ca. 5 N	ca. 2.5 N
Mating cycles	depending on plating			

Technical alterations are subjects to change without notice.

# CRIMPING INSTRUCTIONS FOR COAXIAL CONTACTS

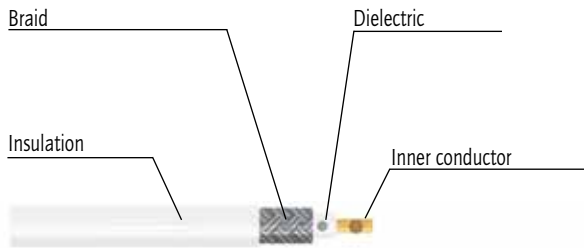

Strip the wire



Slide sleeve over coax cable



Crimp the inner contact on the inner conductor



Snap the inner contact into the outer contact



Slide braid over outer contact



Crimp the sleeve on to outer contact







# TYPE M/2

## Male connector – straight and angled

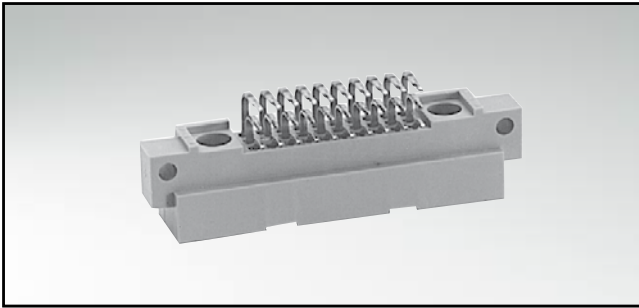

RoHS compliant

### DESCRIPTION

- Solder pin
- No. of Pos. 8+4 - 12+4 - 20+2 - 30+2
- Quality class 3 (also available in quality class 2 or 1)
- Part number creator on page 5 | 2
- For assembly with PCB power and coaxial contacts please contact factory

### PRODUCT DRAWING

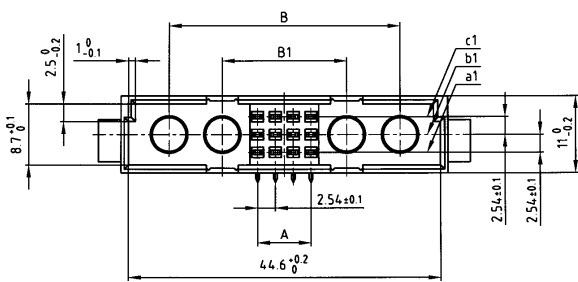

No. of Pos.	A ±0.1	B ±0.1	B1 ±0.1
30 + 2	9x2.54=22.86	13x2.54=33.02	-
20 + 2	9x2.54=22.86	13x2.54=33.02	-
12 + 4	3x2.54=7.62	13x2.54=33.02	7x2.54=17.78
8 + 4	3x2.54=7.62	13x2.54=33.02	7x2.54=17.78

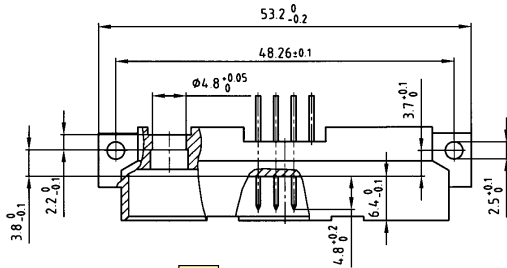

Solder pin angled **T**

Solder pin straight **R**

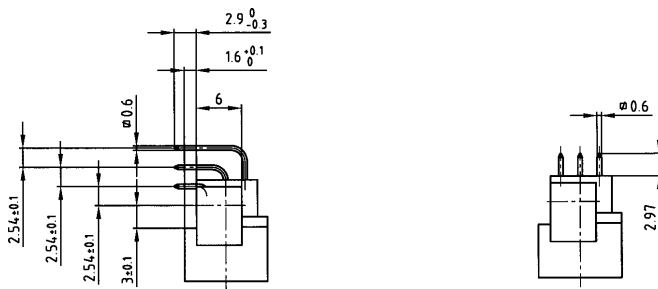

= Ordering code

### ORDER DATA

(Dim. = mm)

No. of Pos.	Version															
	* = contact, + = no contact															
	1	2	3	4	5	6	7	8	9	10	11	12	13	14	15	16
30+2	a	+	•	•	•	•	•	•	•	•	•	•	•	•	•	+
	b	•	•	•	•	•	•	•	•	•	•	•	•	•	•	•
	c	•	•	•	•	•	•	•	•	•	•	•	•	•	•	•
20+2	a	+	+	+	+	+	+	+	+	+	+	+	+	+	+	+
	b	•	•	•	•	•	•	•	•	•	•	•	•	•	•	•
	c	•	•	•	•	•	•	•	•	•	•	•	•	•	•	•

No. of Pos.	Version															
	* = contact, + = no contact															
	1	2	3	4	5	6	7	8	9	10	11	12	13	14	15	16
12+4	a	+	+	•	•	•	•	•	•	•	•	•	•	•	•	•
	b	•	•	•	•	•	•	•	•	•	•	•	•	•	•	•
	c	•	•	•	•	•	•	•	•	•	•	•	•	•	•	•
8+4	a	+	+	+	+	•	•	•	•	•	•	•	•	•	•	•
	b	•	•	•	•	•	•	•	•	•	•	•	•	•	•	•
	c	•	•	•	•	•	•	•	•	•	•	•	•	•	•	•

# TYPE M/2

## Female connector – straight

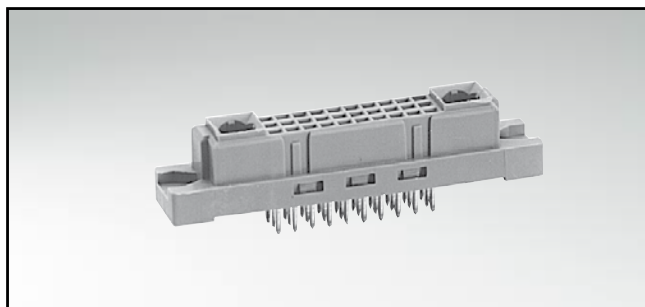

RoHS compliant

### DESCRIPTION

- Solder pin and Wire Wrap
- No. of Pos. 8+4 - 12+4 - 20+2 - 30+2
- Quality class 3 (also available in quality class 2 or 1)
- Part number creator on page 5 | 2
- For assembly with PCB power and coaxial contacts please contact factory

### PRODUCT DRAWING

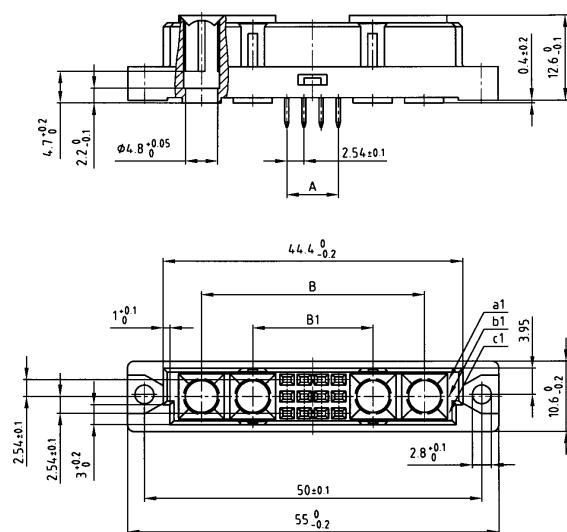

No. of Pos.	A ±0.1	B ±0.1	B <sub>1</sub> ±0.1
30 + 2	9x2.54=22.86	13x2.54=33.02	-
20 + 2	9x2.54=22.86	13x2.54=33.02	-
12 + 4	3x2.54=7.62	13x2.54=33.02	7x2.54=17.78
8 + 4	3x2.54=7.62	13x2.54=33.02	7x2.54=17.78

Solder pin straight 4 mm **R**

Wire Wrap **N**

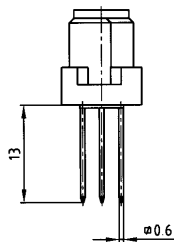
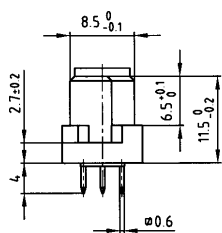

  = Ordering code

(Dim. = mm)

### ORDER DATA

No. of Pos.	Version															
	* = contact, + = no contact															
	1	2	3	4	5	6	7	8	9	10	11	12	13	14	15	16
30+2	a	+	•	•	•	•	•	•	•	•	•	•	•	•	•	+
	b	•	•	•	•	•	•	•	•	•	•	•	•	•	•	•
	c	•	•	•	•	•	•	•	•	•	•	•	•	•	•	•
20+2	a	+	+	+	+	+	+	+	+	+	+	+	+	+	+	+
	b	•	•	•	•	•	•	•	•	•	•	•	•	•	•	•
	c	•	•	•	•	•	•	•	•	•	•	•	•	•	•	•

No. of Pos.	Version															
	* = contact, + = no contact															
	1	2	3	4	5	6	7	8	9	10	11	12	13	14	15	16
12+4	a	+	+	•	•	•	•	•	•	•	•	•	•	•	•	•
	b	•	•	•	•	•	•	•	•	•	•	•	•	•	•	•
	c	•	•	•	•	•	•	•	•	•	•	•	•	•	•	•
8+4	a	+	+	+	+	+	+	+	+	+	+	+	+	+	+	+
	b	•	•	•	•	•	•	•	•	•	•	•	•	•	•	•
	c	•	•	•	•	•	•	•	•	•	•	•	•	•	•	•

# TYPE M

## High power contacts – solder cup – straight

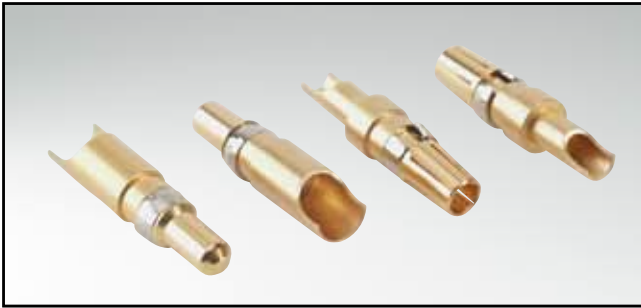

RoHS compliant

### DESCRIPTION

- Precision machined contacts
- Quality class 3: gold flash
- Quality class 1: 0.8µm gold on mating side
- Other quality classes on request
- Assembled contacts available on request

### PRODUCT DRAWING

Socket contact

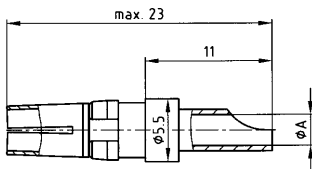

Plug contact

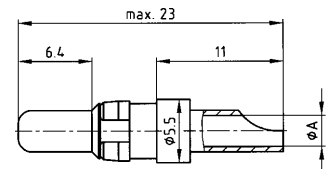

AWG	Current Rating	ØA <sup>+0.15</sup>
16 - 20	10 A	1,80
12 - 14	20 A	2,70
8 - 10	30 A	4,80

Premating contact

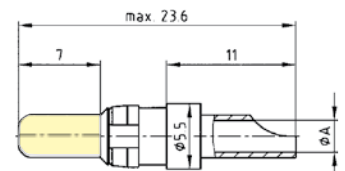

### ORDER DATA

(Dim. = mm)

SOCKET CONTACT				
AWG	Current rating	Quality class	Termination	Part number
16 - 20	10 A	1	11	124 C 10039 X
16 - 20	10 A	3	27	124 A 10039 X
12 - 14	20 A	1	12	124 C 10049 X
12 - 14	20 A	3	28	124 A 10049 X
8 - 10	40 A	1	14	124 C 10069 X
8 - 10	40 A	3	29	124 A 10069 X

PLUG CONTACT				
AWG	Current rating	Quality class	Termination	Part number
16 - 20	10 A	1	11	123 C 10039 X
16 - 20	10 A	3	27	123 A 10039 X
12 - 14	20 A	1	12	123 C 10049 X
12 - 14	20 A	3	28	123 A 10049 X
8 - 10	40 A	1	14	123 C 10069 X
8 - 10	40 A	3	29	123 A 10069 X

PREMATING CONTACT			
AWG	Current rating	Quality class	Part number
16 - 20	10 A	1	123 C 10139 X
12 - 14	20 A	1	123 C 10149 X
8 - 10	40 A	1	123 C 10169 X

# TYPE M

## High power contacts – crimp – straight



RoHS compliant

### DESCRIPTION

- Precision machined contacts
- Quality class 3: gold flash
- Quality class 1: 0.8µm gold on mating side
- Other quality classes on request

### PRODUCT DRAWING

Socket contact

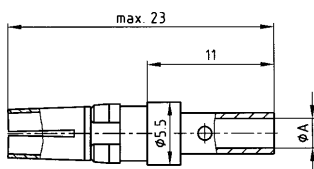

Plug contact

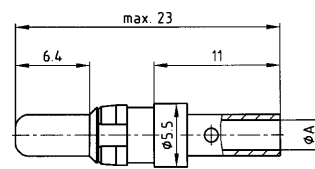

AWG	Current Rating	ØA <sup>+0.15</sup>	ØB max.
16 - 20	10 A	1,70	1,70
12 - 14	20 A	2,60	2,60
10 - 12	30 A	3,70	3,70
8 - 10	40 A	4,60	4,60

Wire stripping

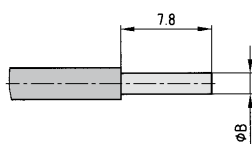

Premating contact

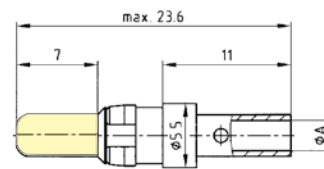

### ORDER DATA

(Dim. = mm)

SOCKET CONTACT				PLUG CONTACT				PREMATING CONTACT			
AWG	Current rating	Quality class	Part number	AWG	Current rating	Quality class	Part number	AWG	Current rating	Quality class	Part number
16 - 20	10 A	1	124 C 11019 X	16 - 20	10 A	1	123 C 11019 X	16 - 20	10 A	1	123 C 11119 X
16 - 20	10 A	3	124 A 11019 X	16 - 20	10 A	3	123 A 11019 X	12 - 14	20 A	1	123 C 11129 X
12 - 14	20 A	1	124 C 11029 X	12 - 14	20 A	1	123 C 11029 X	10 - 12	30 A	1	123 C 11139 X
12 - 14	20 A	3	124 A 11029 X	12 - 14	20 A	3	123 A 11029 X	8 - 10	40 A	1	123 C 11149 X
10 - 12	30 A	1	124 C 11039 X	10 - 12	30 A	1	123 C 11039 X				
10 - 12	30 A	3	124 A 11039 X	10 - 12	30 A	3	123 A 11039 X				
8 - 10	40 A	1	124 C 11049 X	8 - 10	40 A	1	123 C 11049 X				
8 - 10	40 A	3	124 A 11049 X	8 - 10	40 A	3	123 A 11049 X				

# TYPE M

## High power contacts – solder pin – straight

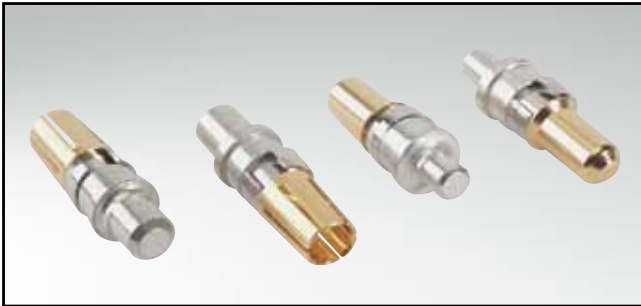

RoHS compliant

### DESCRIPTION

- Precision machined contacts
- Quality class 3: gold flash
- Quality class 1: 0.8µm gold on mating side
- Other quality classes on request
- Assembled contacts available on request

### PRODUCT DRAWING

Socket contact

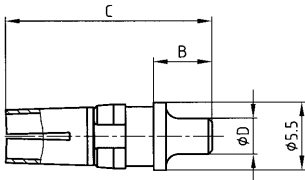

Plug contact

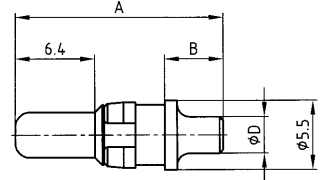

Current rating	A	A <sub>1</sub>	B	C	ØD
20 A	16.70	17.30	4.70	16.10	2.90
40 A	17.75	18.35	5.75	17.15	3.80

Premating contact

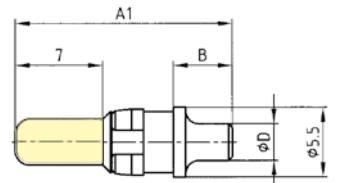

### ORDER DATA

(Dim. = mm)

SOCKET CONTACT			
Current rating	Quality class	Termination	Part number
20 A	1	19	124 C 14029 X
20 A	3	39	124 A 14029 X
40 A	1	20	124 C 14049 X
40 A	3	40	124 A 14049 X

PLUG CONTACT			
Current rating	Quality class	Termination	Part number
20 A	1	19	123 C 14029 X
20 A	3	39	123 A 14029 X
40 A	1	20	123 C 14049 X
40 A	3	40	123 A 14049 X

PREMATING CONTACT			
Current rating	Quality class	Termination	Part number
20 A	1	19	123 C 14129 X
40 A	1	20	123 C 14149 X

# TYPE M

## High power contacts – solder pin – angled

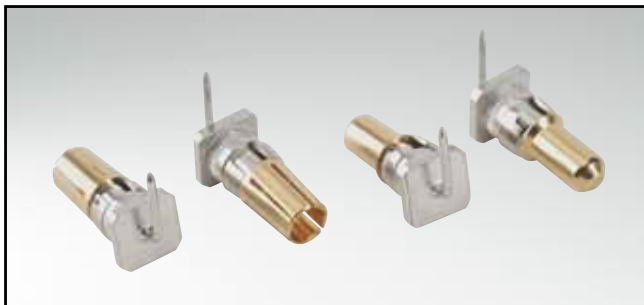

RoHS compliant

### DESCRIPTION

- Precision machined contacts
- Quality class 3: gold flash
- Quality class 1: 0.8µm gold on mating side
- Other quality classes on request
- Assembled contacts available on request

### PRODUCT DRAWING

Socket contact

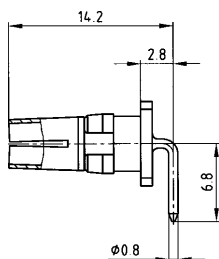

Plug contact

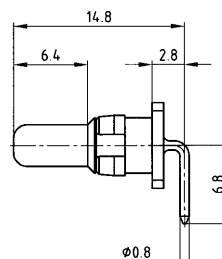

Premating contact

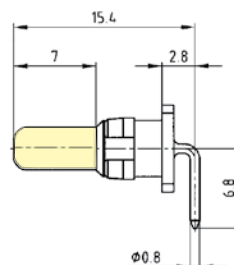

### ORDER DATA

(Dim. = mm)

SOCKET CONTACT			
Current rating	Quality class	Termination	Part number
10 A	1	18	124 C 12019 X
10 A	3	17	124 A 12019 X

PLUG CONTACT			
Current rating	Quality class	Termination	Part number
10 A	1	18	123 C 12019 X
10 A	3	17	123 A 12019 X

PREMATING CONTACT		
Current rating	Quality class	Part number
10 A	1	123 C 12119 X

# TYPE M

## High power contacts – solder pin – angled



RoHS compliant

### DESCRIPTION

- Precision machined contacts
- Quality class 3: gold flash
- Quality class 1: 0.8µm gold on mating side
- Other quality classes on request
- Assembled contacts available on request

### PRODUCT DRAWING

Socket contact

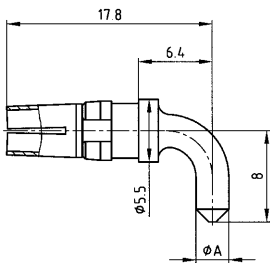

Plug contact

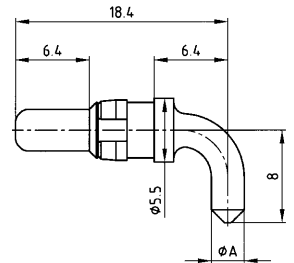

Current Rating	ØA
20 A	2.90
40 A	3.80

Premating contact

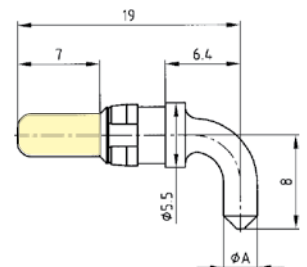

### ORDER DATA

(Dim. = mm)

SOCKET CONTACT			
Current rating	Quality class	Termination	Part number
20 A	1	21	124 C 13019 X
20 A	3	16	124 A 13019 X
40 A	1	23	124 C 13039 X
40 A	3	15	124 A 13039 X

PLUG CONTACT			
Current rating	Quality class	Termination	Part number
20 A	1	21	123 C 13019 X
20 A	3	16	123 A 13019 X
40 A	1	23	123 C 13039 X
40 A	3	15	123 A 13039 X

PREMATING CONTACT		
Current rating	Quality class	Part number
20 A	1	123 C 13119 X
40 A	1	123 C 13139 X

# TYPE M

## High power contacts – solder pin – angled

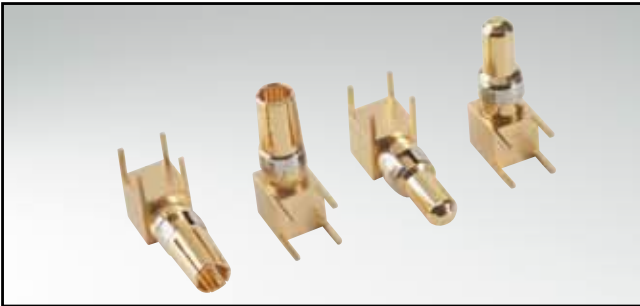

RoHS compliant

### DESCRIPTION

- Precision machined contacts
- Quality class 3: gold flash
- Quality class 1: 0.8µm gold on mating side
- Other quality classes on request
- Assembled contacts available on request

### PRODUCT DRAWING

Socket contact

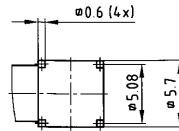
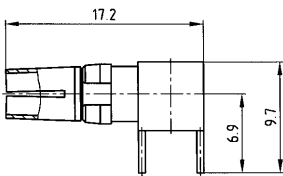

Plug contact

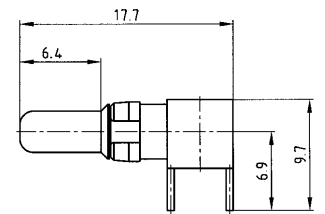

Premating contact

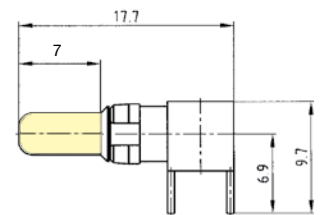

### ORDER DATA

(Dim. = mm)

SOCKET CONTACT			
Current rating	Quality class	Termination	Part number
40 A	1	26	124 C 10019 X
40 A	3	13	124 A 10019 X

PLUG CONTACT			
Current rating	Quality class	Termination	Part number
40 A	1	26	123 C 10019 X
40 A	3	13	123 A 10019 X

PREMATING CONTACT		
Current rating	Quality class	Part number
40 A	1	123 C 10029 X



# TYPE M

Coaxial contacts – straight – inner conductor solder – outer conductor crimp/solder termination



RoHS compliant

## DESCRIPTION

- 50 and 75 Ω Version
- Socket contact suitable for male connectors
- Plug contact suitable for female connectors
- Contact platings:
  - 0.8µm gold mating side inner conductor
  - other platings on request
- Delivery includes: contacts and sleeve supplied loose

## PRODUCT DRAWING

### 50 Ω Version

Socket contact

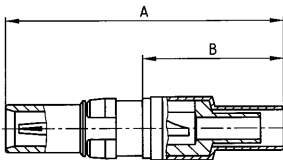

Plug contact

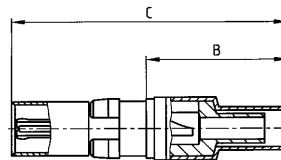

Wire stripping

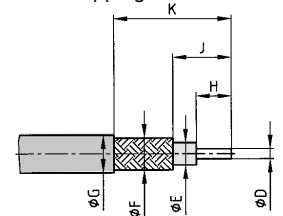

usable cable RG	A	B	C	ØD max.	ØE max.	ØF max.	ØG max.	H	J	K
178 B/U, 196 A/U, 404 U <sup>+</sup>	24.2	12.3	23.9	0.90	1.2	1.4	2.3	2.5	5.0	10.0
174 U, 188 A/U, 316 U	24.2	12.3	23.9	0.80	1.9	2.3	3.2	2.5	5.0	10.0
316 U*	24.2	12.3	23.9	0.90	1.9	2.7	3.5	2.5	5.0	10.0
58 C/U, 141 A/U	25.4	13.5	25.2	0.90	3.0	4.1	5.2	3.0	5.0	9.5

\* = double braided - <sup>+</sup> = low noise

### 75 Ω Version

Socket contact

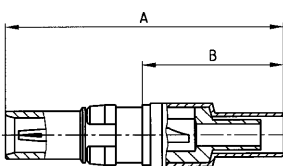

Plug contact

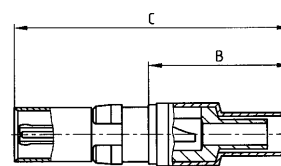

Wire stripping

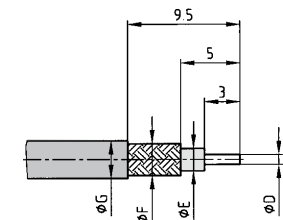

usable cable RG	A	B	C	ØD max.	ØE max.	ØF max.	ØG max.
179 B/U, 187 A/U	24.2	12.3	23.9	0.50	1.9	2.3	3.2
180 B/U	23.1	11.2	22.8	0.90	2.8	3.1	4.5

## ORDER DATA

(Dim. = mm)

SOCKET CONTACT			PLUG CONTACT		
Version	Usable cable RG	Part number	Version	Usable cable RG	Part number
50 Ω	178 B/U, 196 A/U, 404 U <sup>+</sup>	124 C 20059 X	50 Ω	178 B/U, 196 A/U, 404 U <sup>+</sup>	123 C 20059 X
50 Ω	174 U, 188 A/U, 316 U	124 C 20069 X	50 Ω	174 U, 188 A/U, 316 U	123 C 20069 X
50 Ω	316 U *	124 C 20079 X	50 Ω	316 U *	123 C 20079 X
50 Ω	58 C/U, 141 A/U	124 C 20089 X	50 Ω	58 C/U, 141 A/U	123 C 20089 X
75 Ω	179 B/U, 187 A/U	124 C 30039 X	75 Ω	179 B/U, 187 A/U	123 C 30039 X
75 Ω	180 B/U	124 C 30049 X	75 Ω	180 B/U	123 C 30049 X

# TYPE M

Coaxial contacts – straight – inner and outer conductor crimp termination



### DESCRIPTION

- 50 Ω Version
- Socket contact suitable for male connectors
- Plug contact suitable for female connectors
- Contact platings:
  - 0.8µm gold mating side inner conductor
  - other platings on request
- Delivery includes: contacts and sleeve supplied loose

RoHS compliant

### PRODUCT DRAWING

#### 50 Ω Version

Socket contact

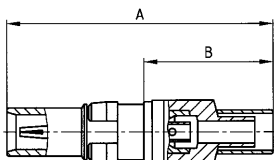

Plug contact

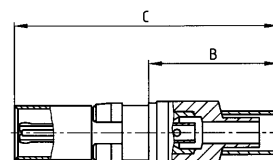

Wire stripping

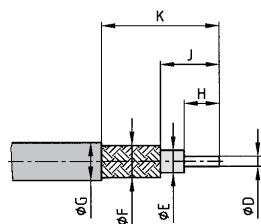

usable cable RG	A	B	C	ØD max.	ØE max.	ØF max.	ØG max.	H	J	K
174 U, 188 A/U, 316 U	23.1	11.2	22.9	0.60	1.9	2.3	3.2	3.0	4.3	9.3
58 C/U, 141 A/U	22.8	10.9	22.6	1.30	3.7	4.4	5.2	3.8	5.3	9.0
316 U*	23.1	11.2	22.9	0.60	1.9	3.0	3.8	3.0	4.3	9.3

\* = double braided

(Dim. = mm)

### ORDER DATA

SOCKET CONTACT			PLUG CONTACT		
Version	Usable cable RG	Part number	Version	Usable cable RG	Part number
50 Ω	174 U, 188 A/U, 316 U	124 C 21049 X	50 Ω	174 U, 188 A/U, 316 U	123 C 21049 X
50 Ω	58 C/U, 141 A/U	124 C 21059 X	50 Ω	58 C/U, 141 A/U	123 C 21059 X
50 Ω	316 U *	124 C 21069 X	50 Ω	316 U *	123 C 21069 X

# TYPE M

Coaxial contacts – angled – inner conductor solder – outer conductor crimp/solder termination



RoHS compliant

## DESCRIPTION

- 50 and 75 Ω Version
- Socket contact suitable for male connectors
- Plug contact suitable for female connectors
- Contact platings:
  - 0.8µm gold mating side inner conductor
  - other platings on request
- Delivery includes: contacts and sleeve supplied loose

## PRODUCT DRAWING

### 50 Ω Version

usable cable RG	A	B	ØD max.	ØE max.	ØF max.	ØG max.
178 B/U, 196 A/U, 404 U <sup>+</sup>	15.7	18.5	0.90	1.2	1.4	2.3
174 U, 188 A/U, 316 U	15.7	18.5	0.90	1.9	2.3	3.2
122 U	15.7	18.5	0.90	2.8	3.1	4.5
316 U*	16.8	19.5	0.90	1.9	2.7	3.5
58 C/U, 141 A/U	18.0	20.8	0.90	3.0	4.1	5.2

\* = double braided - <sup>+</sup> = low noise

Socket contact

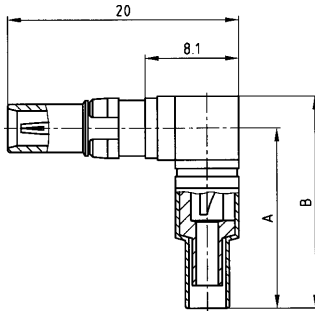

Plug contact

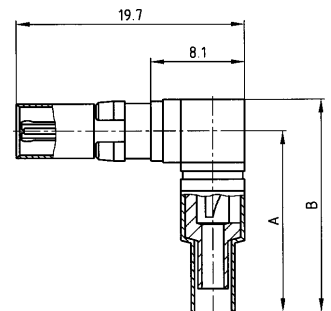

Wire stripping

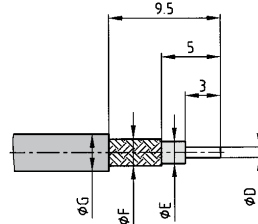

### 75 Ω Version

usable cable RG	A	B	ØD max.	ØE max.	ØF max.	ØG max.
196 A/U	15.7	18.5	0.90	1.2	1.4	2.3
179 B/U, 187 A/U	15.7	18.5	0.90	1.9	2.3	3.2
180 B/U	15.7	18.5	0.90	2.8	3.1	4.5

Socket contact

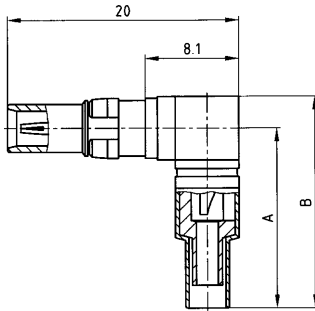

Plug contact

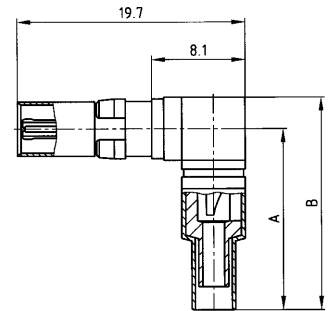

## ORDER DATA

(Dim. = mm)

SOCKET CONTACT		
Version	Usable cable RG	Part number
50 Ω	178 B/U, 196 A/U, 404 U <sup>+</sup>	124 C 22069 X
50 Ω	174 U, 188 A/U, 316 U	124 C 22079 X
50 Ω	316 U *	124 C 22089 X
50 Ω	122 U	124 C 22099 X
50 Ω	58 C/U, 141 A/U	124 C 22109 X
75 Ω	196 A/U	124 C 32049 X
75 Ω	179 B/U, 187 A/U	124 C 32059 X
75 Ω	180 B/U	124 C 32069 X

PLUG CONTACT		
Version	Usable cable RG	Part number
50 Ω	178 B/U, 196 A/U, 404 U <sup>+</sup>	123 C 22069 X
50 Ω	174 U, 188 A/U, 316 U	123 C 22079 X
50 Ω	316 U *	123 C 22089 X
50 Ω	122 U	123 C 22099 X
50 Ω	58 C/U, 141 A/U	123 C 22109 X
75 Ω	196 A/U	123 C 32049 X
75 Ω	179 B/U, 187 A/U	123 C 32059 X
75 Ω	180 B/U	123 C 32069 X

# TYPE M

Coaxial contacts – angled – inner and outer conductor crimp termination



### DESCRIPTION

- 50 Ω and 75 Ω Version
- Socket contact suitable for male connectors
- Plug contact suitable for female connectors
- Contact platings:
  - 0.8µm gold mating side inner conductor
  - other platings on request
- Delivery includes: contacts and sleeve supplied loose

RoHS compliant

### PRODUCT DRAWING

#### 50 Ω Version

usable cable RG	A	B	ØD max.	ØE max.	ØF max.	ØG max.
174 U, 188 A/U, 316 U	15.7	18.5	0.60	1.9	2.3	2.3
316 U*	15.7	18.5	0.60	1.9	3.0	3.8
58 C/U, 141 A/U	15.4	18.2	1.00	3.7	4.4	5.2

Socket contact

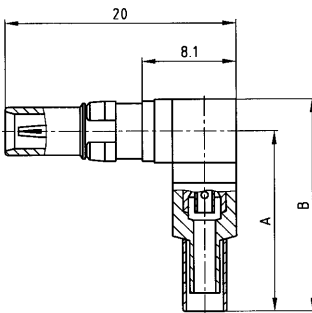

Plug contact

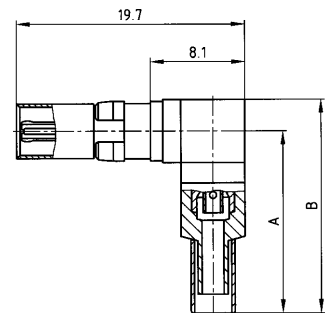

\* = double braided

Wire stripping

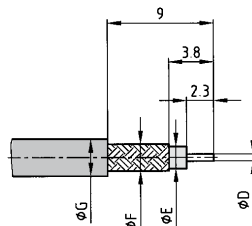

#### 75 Ω Version

Socket contact

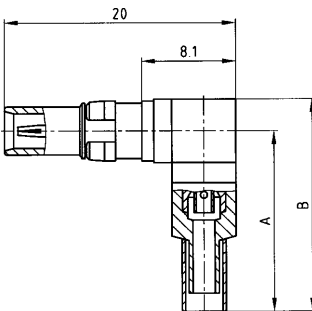

Plug contact

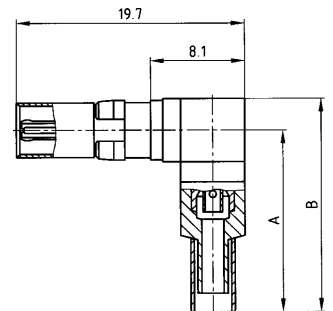

usable cable RG	A	B	ØD max.	ØE max.	ØF max.	ØG max.
179 B/U, 187 A/U	15.7	18.5	0.60	1.9	2.3	3.2
180 B/U	14.9	17.7	0.60	2.8	3.2	4.5

### ORDER DATA

(Dim. = mm)

SOCKET CONTACT		
Version	Usable cable RG	Part number
50 Ω	174 U, 188 A/U, 316 U	124 C 23049 X
50 Ω	316 U *	124 C 23059 X
50 Ω	58 C/U, 141 A/U	124 C 23069 X
75 Ω	179 B/U, 187 A/U	124 C 33039 X
75 Ω	180 B/U	124 C 33049 X

PLUG CONTACT		
Version	Usable cable RG	Part number
50 Ω	174 U, 188 A/U, 316 U	123 C 23049 X
50 Ω	316 U *	123 C 23059 X
50 Ω	58 C/U, 141 A/U	123 C 23069 X
75 Ω	179 B/U, 187 A/U	123 C 33039 X
75 Ω	180 B/U	123 C 33049 X

# TYPE M

Coaxial contacts – straight – PCB termination – 5 solder pins

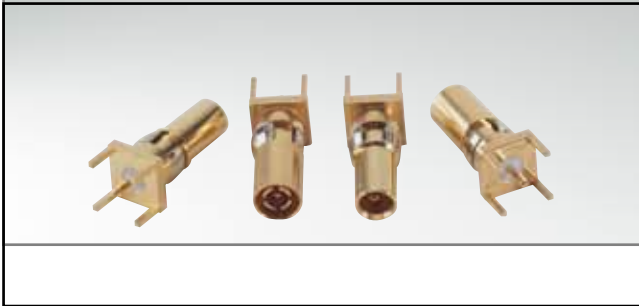

RoHS compliant

## DESCRIPTION

- 50 and 75 Ω Version
- Socket contact suitable for male connectors
- Plug contact suitable for female connectors
- Contact platings:
  - 0.8µm gold mating side inner conductor
  - other platings on request

## PRODUCT DRAWING

### 50 Ω Version

Socket contact

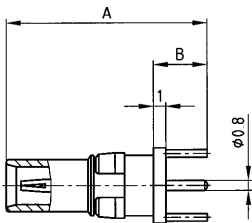

Termination type	A	B	C
31	16.2	4.3	16.0
32	17.7	5.8	17.5

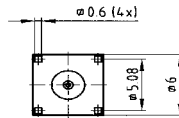

Plug contact

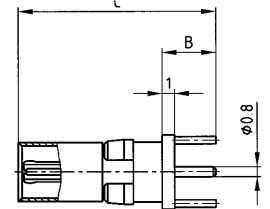

### 75 Ω Version

Socket contact

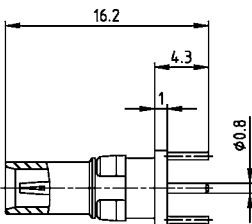

Plug contact

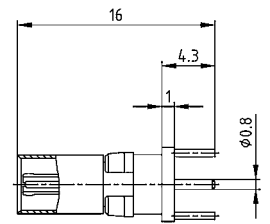

## ORDER DATA

(Dim. = mm)

SOCKET CONTACT		
Version	Termination	Part number
50 Ω	31	124 C 24039 X
50 Ω	32	124 C 24049 X
75 Ω	33	124 C 34029 X

PLUG CONTACT		
Version	Termination	Part number
50 Ω	31	123 C 24039 X
50 Ω	32	123 C 24049 X
75 Ω	33	123 C 34029 X

# TYPE M

## Coaxial contacts – angled – PCB termination – 5 solder pins

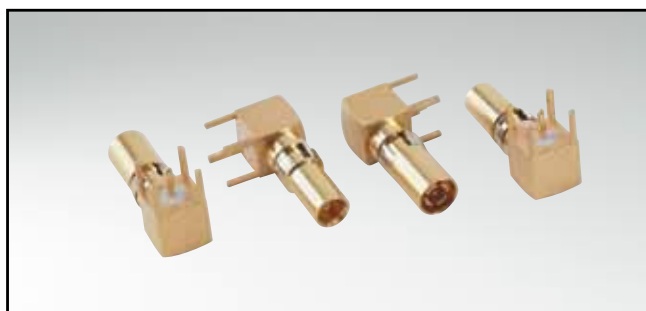

RoHS compliant

### DESCRIPTION

- 50  $\Omega$  and 75  $\Omega$  Version
- Socket contact suitable for male connectors
- Plug contact suitable for female connectors
- Contact platings:
  - 0.8 $\mu$ m gold mating side inner conductor
  - other platings on request

### PRODUCT DRAWING

#### 50 $\Omega$ Version

Socket contact

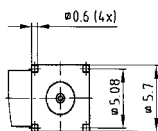
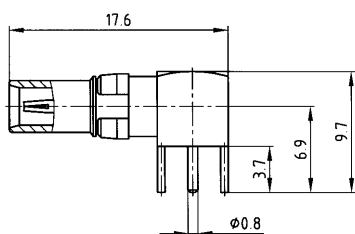

Plug contact

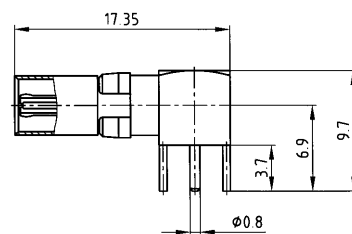

#### 75 $\Omega$ Version

Socket contact

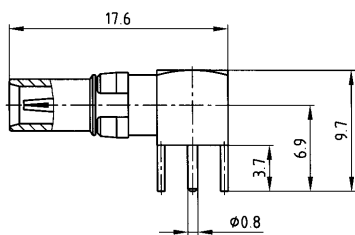

Plug contact

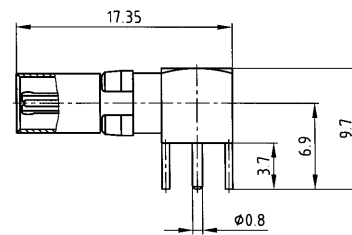

### ORDER DATA

(Dim. = mm)

SOCKET CONTACT			PLUG CONTACT		
Version	Termination	Part number	Version	Termination	Part number
50 $\Omega$	35	124 C 25029 X	50 $\Omega$	35	123 C 25029 X
75 $\Omega$	36	124 C 35029 X	75 $\Omega$	36	123 C 35029 X

По вопросам продаж и поддержки обращайтесь:

Архангельск (8182)63-90-72  
Астана (7172)727-132  
Астрахань (8512)99-46-04  
Барнаул (3852)73-04-60  
Белгород (4722)40-23-64  
Брянск (4832)59-03-52  
Владивосток (423)249-28-31  
Волгоград (844)278-03-48  
Вологда (8172)26-41-59  
Воронеж (473)204-51-73  
Екатеринбург (343)384-55-89

Иваново (4932)77-34-06  
Ижевск (3412)26-03-58  
Казань (843)206-01-48  
Калининград (4012)72-03-81  
Калуга (4842)92-23-67  
Кемерово (3842)65-04-62  
Киров (8332)68-02-04  
Краснодар (861)203-40-90  
Красноярск (391)204-63-61  
Курск (4712)77-13-04  
Липецк (4742)52-20-81

Магнитогорск (3519)55-03-13  
Москва (495)268-04-70  
Мурманск (8152)59-64-93  
Набережные Челны (8552)20-53-41  
Нижний Новгород (831)429-08-12  
Новокузнецк (3843)20-46-81  
Новосибирск (383)227-86-73  
Омск (3812)21-46-40  
Орел (4862)44-53-42  
Оренбург (3532)37-68-04  
Пенза (8412)22-31-16

Пермь (342)205-81-47  
Ростов-на-Дону (863)308-18-15  
Рязань (4912)46-61-64  
Самара (846)206-03-16  
Санкт-Петербург (812)309-46-40  
Саратов (845)249-38-78  
Севастополь (8692)22-31-93  
Симферополь (3652)67-13-56  
Смоленск (4812)29-41-54  
Сочи (862)225-72-31  
Ставрополь (8652)20-65-13

Сургут (3462)77-98-35  
Тверь (4822)63-31-35  
Томск (3822)98-41-53  
Тула (4872)74-02-29  
Тюмень (3452)66-21-18  
Ульяновск (8422)24-23-59  
Уфа (347)229-48-12  
Хабаровск (4212)92-98-04  
Челябинск (351)202-03-61  
Череповец (8202)49-02-64  
Ярославль (4852)69-52-93

Единый адрес: [ccn@nt-rt.ru](mailto:ccn@nt-rt.ru) | <http://www.conec.nt-rt.ru>